

Nikon

En

The Nikon Guide to Digital Photography
with the

COOLPIX P3

DIGITAL CAMERA



Trademark Information

Apple, the Apple logo, Macintosh, Mac OS, and QuickTime are registered trademarks of Apple Computer, Inc. Finder is trademark of Apple Computer, Inc. Microsoft and Windows are registered trademarks of Microsoft Corporation. Internet is a trademark of Digital Equipment Corporation. Adobe and Acrobat are registered trademarks of Adobe Systems Inc. The SD logo is a trademark of the SD Card Association. PictBridge is a trademark. Face-priority AF technology is provided by Identix[®]. D-Lighting technology is provided by  Apical Limited. All other trade names mentioned in this manual or the other documentation provided with your Nikon product are trademarks or registered trademarks of their respective holders.

Apple Public Source License

This product includes Apple mDNS source code that is subject to the terms of the Apple Public Source License located at URL <http://developer.apple.com/darwin/>.

Portions Copyright (c) 1999-2004 Apple Computer, Inc. All Rights Reserved.

This file contains Original Code and/or Modifications of Original Code as defined in and that are subject to the Apple Public Source License Version 2.0 (the 'License'). You may not use this file except in compliance with the License.

Please obtain a copy of the License at <http://www.opensource.apple.com/apsl/> and read it before using this file.

The Original Code and all software distributed under the License are distributed on an 'AS IS' basis, WITHOUT WARRANTY OF ANY KIND, EITHER EXPRESS OR IMPLIED, AND APPLE HEREBY DISCLAIMS ALL SUCH WARRANTIES, INCLUDING WITHOUT LIMITATION, ANY WARRANTIES OF MERCHANTABILITY, FITNESS FOR A PARTICULAR PURPOSE, QUIET ENJOYMENT OR NON-INFRINGEMENT. Please see the License for the specific language governing rights and limitations under the License.

Thank you for your purchase of a Nikon COOLPIX P3 digital camera. This manual has been written to help you enjoy taking pictures with your Nikon digital camera. Read this manual thoroughly before use, and keep it handy when using the product.

Symbols Used in This Manual



These notes should be read before using the camera and contain general information or information that should be read and followed to prevent malfunction.



This icon marks tips, additional information that may be helpful when using the camera.

- On-screen menu items (such as **DaylightSaving**) appear in bold in this manual.
- The settings for the various functions and menus in the camera at the time of purchase are indicated by “default setting”.
- SD memory cards are also referred to as memory cards.
- In order to make illustrations in this manual easier to understand, subjects are sometimes not included.

Illustrations and on-screen text in this manual may differ from the actual display.

Before You Begin

First Steps

**Basic Photography
and Playback**

Selecting Scene Mode

**Additional Shooting
Options**

**Viewing Pictures on
the Camera**

**Recording and
Viewing Movies**



**TV, Computer or
Printer Connection**

**Advanced Camera
Settings**

**Wireless Transfer
Mode**

Technical Notes

Table of Contents

Before You Begin	6
For Your Safety	6
Notices.....	8
Introduction	11
Parts of the Camera	12
The Monitor	14
First Steps.....	16
Charging the Battery.....	16
Inserting the Battery.....	18
Inserting Memory Cards	20
Basic Setup.....	22
Basic Photography and Playback	24
 Mode	24
Step 1. Select  mode.....	24
Step 2. Turn camera on.....	24
Step 3. Frame picture.....	25
Step 4. Focus and shoot.....	26
Viewing Pictures.....	27
Deleting Pictures.....	27
Using the Flash.....	28
Taking Pictures with the Self-Timer	30
Selecting Focus Option	31
Exposure Compensation.....	32
Selecting Scene Mode	33
Scene Mode.....	33
Additional Shooting Options	41
Using Exposure Control.....	41
Selecting Image Quality and Size	43
Using ISO Sensitivity	45
Setting White Balance	46
Using Vibration Reduction (VR).....	48

Viewing Pictures on the Camera	49
Full-screen Playback Mode	49
Viewing Multiple Pictures: Thumbnail Playback	50
Histogram Display	51
Deleting Pictures	51
Taking a Closer Look	52
Quick Playback Zoom	52
Playback Zoom	53
Creating a Cropped Copy	54
Voice Memos	55
Recording Voice Memos	55
Playing Back Voice Memos	55
Deleting Voice Memos	55
Recording and Viewing Movies.....	56
Selecting Movie Options	56
Selecting Movie Options	56
Selecting Auto-Focus Mode	57
Recording Movies	58
Recording a Time-Lapse Movie	59
Movie Playback	60
TV, Computer or Printer Connection.....	61
Connecting to a TV	61
Connecting to a Computer	62
Connecting to a Printer	67
Connecting the Camera to a Printer	68
Printing Pictures One at a Time	69
Printing Multiple Pictures	70
Creating a DPOF Print Order: Print Set	72

Advanced Camera Settings.....	76
Using the Menu.....	76
Displaying the Menu.....	76
Navigating the Menu.....	77
The Shooting Menu.....	78
Metering.....	79
Continuous.....	80
BSS.....	82
Auto Bracketing.....	83
Image Adjustment.....	84
Image Sharpening.....	84
Saturation Control.....	85
AF Area Mode.....	86
Auto-focus Mode.....	87
Fixed Aperture.....	88
Noise Reduction.....	88
The Playback Menu.....	89
Navigating the Picture Selection Screen.....	90
Navigating the Choose Date Screen.....	91
List by Date.....	92
D-Lighting.....	92
Slide Show.....	93
Delete.....	94
Protect.....	94
Transfer Marking.....	95
Small Pic.....	96
Copy.....	97
The Set-up Menu.....	98
Menu.....	99
Welcome Screen.....	99
Date.....	100
Monitor Settings.....	101
Date Imprint.....	102
Shot Confirmation.....	104
AF Assist.....	104
Sound Settings.....	105
Auto Off.....	105
Format Memory/Card.....	106
Language.....	106
Interface (USB/Video Mode).....	107
Auto Transfer.....	107
Reset All.....	108
Firmware Version.....	108

Wireless Transfer Mode	109
What is Wireless Transfer Mode?	109
Setting Up Wireless Transfer Mode	110
Confirming Profiles	120
Transferring Images to a Computer	121
Transferring Images to a Printer	130
Technical Notes	132
Optional Accessories	132
Caring for Your Camera	133
Error Messages	136
Troubleshooting	140
Appendix	143
Specifications	151
Index	155

For Your Safety

To prevent damage to your Nikon product or injury to yourself or to others, read the following safety precautions in their entirety before using this equipment. Keep this manual where all those who use the product will read them.

The consequences that could result from failure to observe the precautions listed in this section are indicated by the following symbol:



This icon marks warnings, information that should be read before using this product to prevent possible injury.

WARNINGS



Turn off in the event of malfunction

Should you notice smoke or an unusual smell coming from the camera, battery charger, or AC adapter (available separately), unplug the battery charger or AC adapter and remove the battery immediately, taking care to avoid burns. Continued operation could result in injury. After removing or disconnecting the power source, take the equipment to a Nikon-authorized service representative for inspection.



Do not use in the presence of flammable gas

Do not use electronic equipment in the presence of flammable gas, as this could result in explosion or fire.



Handle the camera strap with care

Do not place strap around the neck of an infant or child.



Keep out of reach of children

Particular care should be taken to prevent infants from putting the batteries or other small parts into their mouths.



Do not disassemble

Touching the internal parts of the camera or battery charger could result in injury. Repairs should be performed only by qualified technicians. Should the camera or battery charger break open as the result of a fall or other accident, take the product to a Nikon-authorized service representative for inspection after unplugging the product and/or removing the battery.



Observe the following precautions when handling the battery charger

- Keep dry. Failure to observe this precaution could result in fire or electric shock.
- Dust on or near the metal parts of the plug should be removed with a dry cloth. Continued use could result in fire.
- Do not handle the power cable or go near the battery charger during thunderstorms. Failure to observe this precaution could result in electric shock.
- Do not damage, modify, forcibly tug or bend the power cable, place it under heavy objects, or expose it to heat or flame. Should the insulation be damaged and the wires become exposed, take it to a Nikon-authorized service representative for inspection. Failure to observe these precautions could result in fire or electric shock.

- Do not handle the plug or battery charger with wet hands. Failure to observe this precaution could result in electric shock.



Observe proper precautions when handling batteries

Batteries may leak or explode if improperly handled. Observe the following precautions when handling a battery for use in this product:

- Before replacing the battery, turn the product off and make sure the power-on lamp has gone out. If you are using an AC adapter, be sure it is unplugged.
- Use only rechargeable Nikon EN-EL5 lithium-ion batteries (supplied).
- When inserting the battery, do not attempt to insert it upside down or backwards.
- Do not short or disassemble batteries.
- Do not expose batteries to flame or to excessive heat.
- Do not immerse in or expose to water.
- Replace the terminal cover when transporting the battery. Do not transport or store with metal objects such as necklaces or hairpins.
- Batteries are prone to leakage when fully discharged. To avoid damage to the product, be sure to remove the battery when no charge remains.
- Immediately after use, or when the product is used on battery power for an extended period, the battery may become hot. Before removing the battery, turn the camera off and allow the battery to cool.
- Discontinue use immediately should you notice any change in the battery, such as discoloration or deformation.



Use appropriate cables, batteries, battery chargers, and AC adapters

Use only the cables, batteries, battery chargers, and AC adapters provided or sold by Nikon for the purpose, to maintain compliance with product regulations.



Removing memory cards

Memory cards may become hot during use. Observe due caution when removing memory cards from the camera.



Handle moving parts with care

Be careful that your fingers or other objects are not pinched by the lens or other moving parts.



CD-ROMs

The CD-ROMs on which the software and manuals are distributed should not be played back on audio CD equipment. Playing CD-ROMs on an audio CD player could cause hearing loss or damage the equipment.



Observe caution when operating the flash

Using the flash close to your subject's eyes could cause temporary visual impairment. Particular care should be observed if photographing infants, when the flash should be no less than one meter (39 in.) from the subject.



Do not fire the unit while the flash head is touching a person or object

Such use can result in the person being burned, and/or their clothes igniting from the heat of the flash's firing.



Avoid contact with liquid crystal

Should the monitor break, care should be taken to avoid injury due to broken glass and to prevent liquid crystal from the monitor touching the skin or entering the eyes or mouth.



Keep dry

Do not immerse in or expose to water. Continuing to use the product under such circumstances may cause fire or an electric shock.



Follow the instructions of hospital and airline personnel

This device emits radio frequency radiation that could interfere with medical or navigational equipment. Do not use this device in a hospital or on board an airplane without first obtaining the permission of hospital or airline staff.

Notices

- No part of the manuals included with this product may be reproduced, transmitted, transcribed, stored in a retrieval system, or translated into any language in any form, by any means, without Nikon's prior written permission.
- Nikon reserves the right to change the specifications of the hardware and software described in these manuals at any time and without prior notice.
- Nikon will not be held liable for any damages resulting from the use of this product.
- While every effort has been made to ensure that the information in these manuals is accurate and complete, we would appreciate it were you to bring any errors or omissions to the attention of the Nikon representative in your area (address provided separately).

This product, which contains encryption software developed in the United States, is controlled by the United States Export Administration Regulations and may not be exported or re-exported to any country to which the United States embargoes goods. As of November 2005 the following countries were subject to embargo: Cuba, Iran, North Korea, Libya, Sudan, and Syria.

Notice for customers in the U.S.A.

Federal Communications Commission (FCC)

Declaration of Conformity

This device complies with Part 15 of the FCC rules. Operation of the device is subject to the following two conditions: (1) this device may not cause harmful interference, and (2) this device must accept any interference received, including interference that may cause undesired operation.

Products that contain a radio transmitter are labeled with FCC ID and may also carry the FCC logo.

FCC Radio Frequency Interference Statement

This equipment has been tested and found to comply with the limits for a Class B digital device, pursuant to Part 15 of the FCC rules. These limits are designed to provide reasonable protection against harmful interference in a residential installation. This equipment generates, uses, and can radiate radio frequency energy and, if not installed and used in accordance with the instructions, may cause harmful interference to radio communications. However, there is no guarantee that interference will not occur in a particular installation. If this equipment does cause harmful interference to radio or television reception, which can be determined by turning the equipment off and on, the user is encouraged to try to correct the interference by one or more of the following measures:

- Reorient or relocate the receiving antenna.

- Increase the separation between the equipment and receiver.
- Connect the equipment into an outlet on a circuit different from that to which the receiver is connected.
- Consult the dealer or an experienced radio/television technician for help.

FCC Radiation Exposure Statement

The available scientific evidence does not show that any health problems are associated with using low power wireless devices. There is no proof, however, that these low power wireless devices are absolutely safe. Low power Wireless devices emit low levels of radio frequency energy (RF) in the microwave range while being used. Whereas high levels of RF can produce health effects (by heating tissue), exposure to low level RF that does not produce heating effects causes no known adverse health effects. Many studies of low level RF exposures have not found any biological effects. Some studies have suggested that some biological effects might occur, but such findings have not been confirmed by additional research. The NIKON COOLPIX P3 has been tested and found to comply with the Federal Communications Commission (FCC) guidelines on radio frequency energy (RF) exposures. The maximum SAR levels tested for the NIKON COOLPIX P3 has been shown to be 0.131 W/kg at Body.

This device should not be co-located or operated with any other antenna or transmitter.

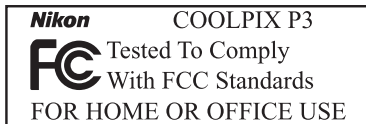

CAUTIONS

Modifications

The FCC requires the user to be notified that any changes or modifications made to this device that are not expressly approved by Nikon Corporation may void the user's authority to operate the equipment.

Notice for customers in Canada

CAUTION

This class B digital apparatus meets all requirements of the Canadian Interference Causing Equipment Regulations.

RSS-210 14. Exposure of Humans to RF Fields

The installer of this radio equipment must ensure that the antenna is located or pointed such that it does not emit RF field in excess of Health Canada limits for the general population; consult Safety Code 6, obtainable from Health Canada's website

www.hc-sc.gc.ca/rpb

Notice for customers in Europe

Hereby, Nikon, declares that this digital camera is in compliance with the essential requirements and other relevant provisions of Directive 1999/5/EC.

Interface Cables

Use the interface cables sold or provided by Nikon for your equipment. Using other interface cables may exceed the limits of Class B Part 15 of the FCC rules.

Notice for customers in the State of California

WARNING: Handling the cord on this product will expose you to lead, a chemical known to the State of California to cause birth defects or other reproductive harm. **Wash hands after handling.**

Nikon Inc.,
1300 Walt Whitman Road, Melville, New York
11747-3064, U.S.A.
Tel.: 631-547-4200

ATTENTION

Cet appareil numérique de la classe B respecte toutes les exigences du Règlement sur le matériel brouilleur du Canada.

Symbol for separate collection applicable in European countries



This symbol indicates that this product is to be collected separately. The following apply only to users in European countries.

- This product is designated for separate collection at an appropriate collection point. Do not dispose of as household waste.
- For more information, contact the retailer or the local authorities in charge of waste management.

Disposing of Data Storage Devices

Please note that deleting data, such as images and profile information, or formatting data storage devices, such as memory card or built-in camera memory, does not completely erase the original data. Deleted data can sometimes be recovered from discarded storage devices using commercially available software, potentially resulting in the malicious use of personal data. Ensuring the privacy of such data is the user's responsibility.

Before discarding a data storage device or transferring ownership to another person, erase all data using commercial deletion software, or format the device and then completely refill it with images containing no private information (for example, pictures of empty sky). Be sure to also replace any pictures selected for the welcome screen. Care should be taken to avoid injury or damage to property when physically destroying data storage devices.

Notice Concerning Prohibition of Copying or Reproduction

Note that simply being in possession of material that has been digitally copied or reproduced by means of a scanner, digital camera or other device may be punishable by law.

- **Items prohibited by law from being copied or reproduced**
Do not copy or reproduce paper money, coins, securities, government bonds, or local government bonds, even if such copies or reproductions are stamped "Sample".

The copying or reproduction of paper money, coins, or securities which are circulated in a foreign country is prohibited.

Unless the prior permission of the government has been obtained, the copying or reproduction of unused postage stamps or post cards issued by the government is prohibited.



The copying or reproduction of stamps issued by the government and of certified documents stipulated by law is prohibited.
- **Cautions on certain copies and reproductions**
The government has issued cautions on copies or reproductions of securities issued by private companies (shares, bills, checks, gift certificates, etc.), commuter passes, or coupon tickets, except when a minimum of necessary copies are to be provided for business use by a company. Also, do not copy or reproduce passports issued by the government, licenses issued by public agencies and private groups, ID cards, and tickets, such as passes and meal coupons.
- **Comply with copyright notices**
The copying or reproduction of copyrighted creative works such as books, music, paintings, woodcut prints, maps, drawings, movies, and photographs is governed by national and international copyright laws. Do not use this product for the purpose of making illegal copies or to infringe copyright laws.

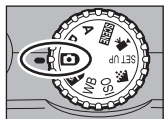

Parts of the Camera

Mode dial



To select a mode, align the mode icon with  next to the mode dial.

	Auto shooting mode (P.24)
P/A	Exposure mode (P.41)
SCENE	Scene mode (P.33)
	Movie mode (P.56)
SET UP	Setup mode (P.98)

	Image mode (P.43)
ISO	ISO Sensitivity mode (P.45)
WB	White balance mode (P.46)
	Wireless transfer mode (P.109)

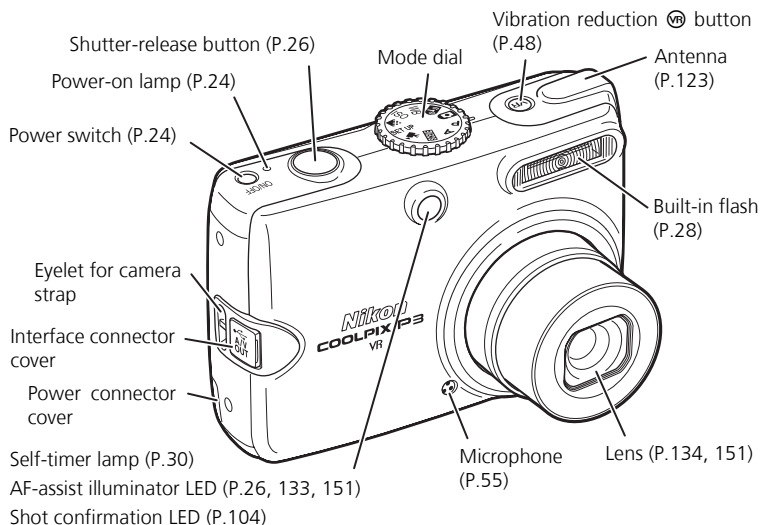

Attaching the camera strap

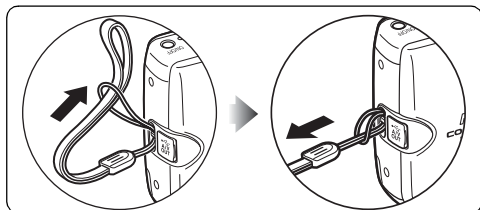

Lens not extended

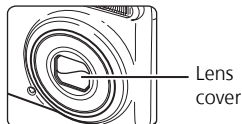

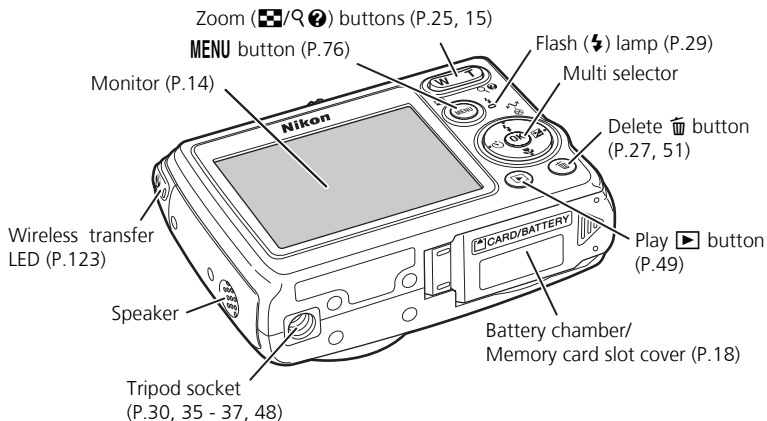

Multi selector

Press the multi selector up, down, left, or right to highlight pictures and menu items, then press **OK** to select. The buttons on the multi selector are also used to:

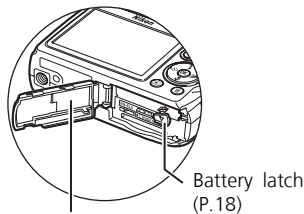
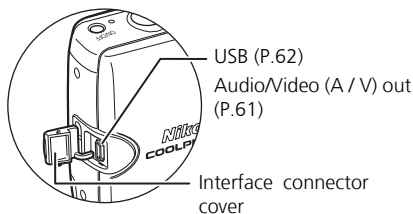
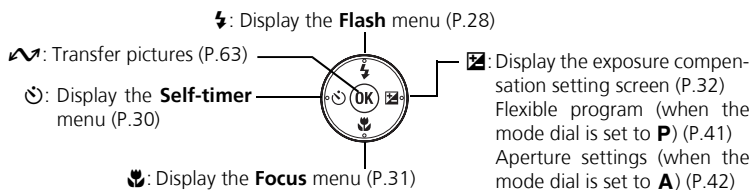

Battery chamber/
Memory card slot cover (P.18)

The Monitor

Shooting

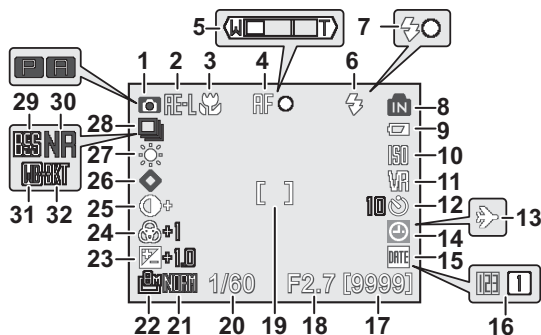

Icons displayed vary with camera settings.

1	Shooting mode	24, 33, 41, 58	21	Image quality	43
2	AE-L indicator ¹⁾	40	22	Image size	43
3	Focus mode	31	23	Exposure compensation	32
4	Focus indicator ²⁾	26	24	Saturation control	85
5	Zoom indicator ³⁾	25	25	Image adjustment	84
6	Flash mode	28	26	Image sharpening	84
7	Flash indicator	29	27	White balance	46
8	Internal memory/Memory card indicator	26	28	Continuous shooting mode	80
9	Battery level indicator ⁴⁾	24	29	Best Shot Selector (BSS)	82
10	ISO Sensitivity	45	30	Noise reduction	88
11	Vibration reduction (VR)	48	31	White balance bracketing ⁸⁾	83
12	Self-timer indicator	30	32	Bracketing ⁹⁾	83
13	Time zone indicator ⁵⁾	100			
14	"Date not set" icon ⁶⁾	136			
15	Date imprint indicator	102			
16	Date counter/Stored date number	103			
17	Number of exposures remaining/Length of movie	58, 145			
18	Aperture	42			
19	Focus area ⁷⁾	26, 86			
20	Shutter speed	41			

1) Appears when taking a picture in **Ⓜ PANORAMA ASSIST** mode.

2) Appears when the shutter-release button is pressed halfway.

3) Appears when the zoom buttons are pressed.

4) Appears when the battery is running low.

5) Appears when the new city time zone has been set.

6) Blinks when the camera clock has not been set.

7) Indicates the area in focus when the shutter-release button is pressed halfway.

8) Appears when **AUTO BRACKETING** has been set to **WB** (white balance) **bracketing**.

9) Appears when **AUTO BRACKETING** has been set to **Auto bracketing**.

Playback

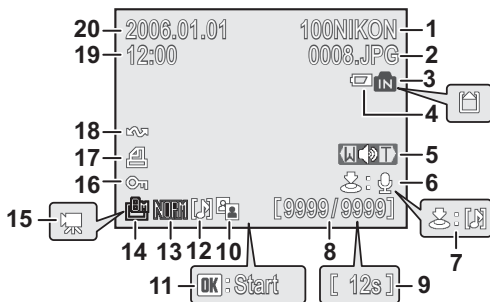

Icons displayed vary with camera settings.

1 Current folder	147	11 Movie playback icon	60
2 File number and type	147	12 Voice memo indicator	55
3 Internal memory/Memory card indicator	26	13 Image quality	43
4 Battery level indicator ¹⁾	24	14 Image size	43
5 Volume indicator	60	15 Movie indicator	58
6 Voice memo recording guide	55	16 Protect icon	94
7 Voice memo playback guide	55	17 Print order icon	72
8 Current frame number/Total number of frames	49	18 Transfer marking icon	95
9 Length of movie	60	19 Recording time	22
10 D-Lighting icon	92	20 Recording date	22

1) Appears when the battery is running low.



Displaying Help Dialogs

This camera displays explanations about the various modes and menus on the monitor. Pressing **?** (Help) when displaying a menu (P.33, 56, 76) displays the help dialog for the selected scene or item. Pressing **OK** while displaying the help dialog performs the function.

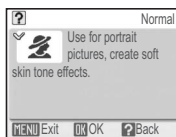

Charging the Battery

The camera uses the supplied EN-EL5 rechargeable lithium-ion battery. Fully charge the battery with the supplied MH-61 battery charger before first use or when the battery is running low.

- 1** Establish power cable connection.
Connect the power cable to the battery charger (①) and to a power outlet (②). The CHARGE lamp will light (③) to indicate that the charger is on.

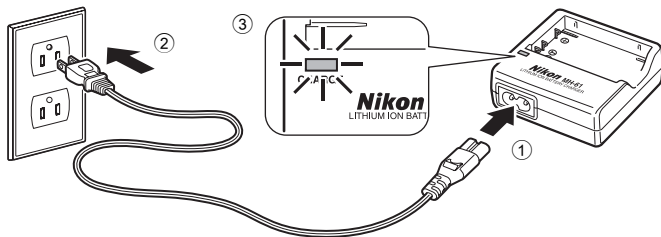

✓ Notes on the Battery Charger

- The MH-61 battery charger is for use with the EN-EL5 battery. Do not use with other batteries.
- Before using the MH-61 battery charger, read and follow the warnings and notices on pages 6 and 7 of this manual.
- The supplied power cable is intended solely for use with the MH-61 and is for domestic use only. It may be necessary to purchase another cable for use abroad; consult with a local Nikon-authorized retailer or service representative.

✓ Note on the Battery

Before using the EN-EL5 battery, read and follow the warnings and notices on pages 6, 7 and 135 of this manual.

- 2** Charge battery.
Insert the battery into the charger as illustrated.

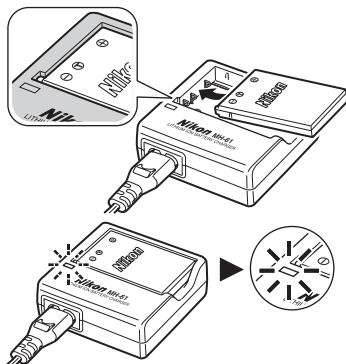

- The CHARGE lamp starts blinking when the battery is correctly inserted. Charging is complete when the lamp stops blinking.
- A new or fully exhausted battery will charge in approximately 2 hours.

Blinks	Battery is charging.
On	Charging is complete.
Flickers	<ul style="list-style-type: none"> • The battery is charging beyond the designated temperature range. Ambient temperature should be in the range of 0 to 40°C (32 to 104°F). • A charging error has occurred. Immediately unplug the wall plug from the power outlet. Contact your local retailer or Nikon representative for details.

- 3** When charging is complete, remove battery from charger and unplug wall plug from power outlet.
- Unplug the wall plug from the power outlet when not in use.

Inserting the Battery

Insert a fully-charged EN-EL5 battery into the camera.

First Steps

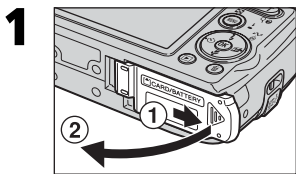

Open battery chamber/memory card slot cover. Slide the cover until it stops (1) and open it (2).

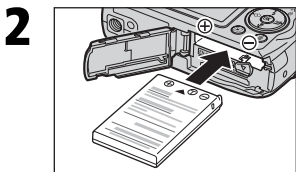

Insert battery.

- Confirm that the positive \oplus and negative \ominus terminals are oriented correctly as described on the label at the entrance of the battery chamber, and insert the battery.

✓ Inserting the Battery

Inserting the battery upside down or backwards could damage the camera. Confirm that the battery is oriented correctly.

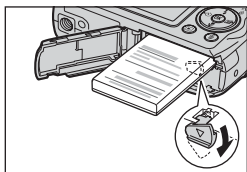
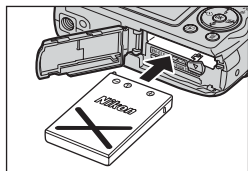

- The orange battery latch is pushed aside when the battery is inserted. The latch will close when the battery is fully inserted. Confirm that the battery latch is secured over the battery and that the battery is set.

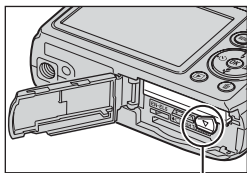

Battery latch

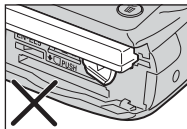
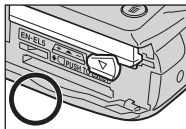

3

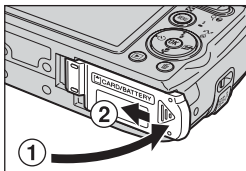

Close battery chamber/memory card slot cover. Close the cover (①) and slide it until it latches (②).

- Confirm that the cover is closed firmly.

The Battery Chamber/Memory Card Slot Cover

- The camera cannot be turned on when the battery chamber/memory card slot cover is open.
- If the battery chamber/memory card slot cover is opened while the camera is on, the camera turns off and the lens retracts.

Removing the Battery

Turn the camera off and confirm that the power-on lamp has gone out before opening the battery chamber/memory card slot cover. Move the battery latch in the direction of the arrow to eject the battery, which can then be removed by hand.

- Note that the battery may become hot during use. Observe due caution when removing it.

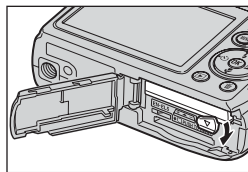

Alternative Power Sources

To power the camera continuously for extended periods, use the optional EH-62A AC adapter kit. **Do not use other AC adapter kits.** It may cause overheating or damage to the camera.

Inserting Memory Cards

First Steps

Pictures can be stored in the camera's internal memory (approximately 23 MB) or on an optional Secure Digital (SD) memory card.

If a memory card is inserted in the camera, pictures will automatically be stored on the card and only the pictures stored on it are played back or deleted. To store, play back or delete pictures in the internal memory, remove the memory card.

1

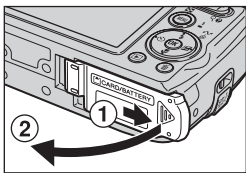

Confirm that camera is off and open battery chamber/memory card slot cover. Slide the cover until it stops (①) and open it (②).

2

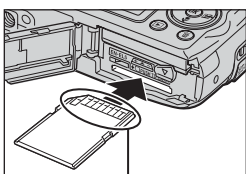

Terminal

Insert memory card.

Insert the memory card (terminal first) in the direction of the arrow shown on the label at the entrance to the memory card slot until it clicks.



Inserting Memory Cards

Inserting the card upside down or backwards could damage the camera or the card. Confirm that the card is oriented correctly.

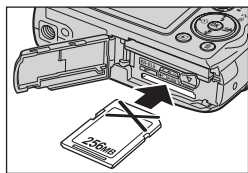

3

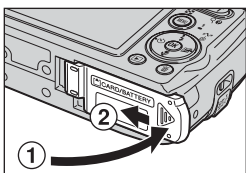

Close battery chamber/memory card slot cover. Close the cover (①) and slide it until it latches (②).

- Confirm that the cover is closed firmly.

4

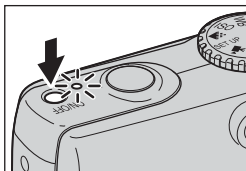

Turn camera on.

The power lamp will light and the monitor will turn on.

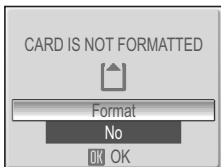

✓ Formatting Memory Cards

When the screen at left is displayed, press the multi selector up to highlight **Format** and then press **OK**.

- Do not turn the camera off or remove the battery or memory card until formatting is complete.
- You can take pictures after formatting is complete.
- **Note that formatting deletes all pictures and other data on the memory card. Before formatting, be sure to make copies of any pictures you wish to keep.**

✓ Removing Memory Cards

Turn the camera off and confirm that the power-on lamp has gone out before removing memory cards. Open the battery chamber/memory card slot cover and press the card to pop it up. The card can then be removed by hand.

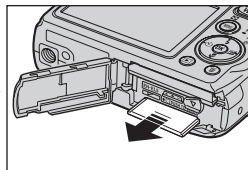
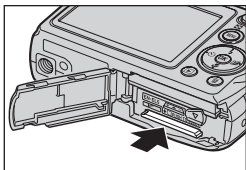

- Note that the memory card may become hot during use. Observe due caution when removing it.

✓ Note on the Write Protect Switch

SD memory cards are equipped with a write protect switch. Pictures cannot be recorded or deleted and the memory card cannot be formatted when this switch is in the "lock" position. Unlock by sliding the switch to the "write" position before taking, editing or deleting pictures, transferring images to a computer, using Wireless transfer mode, or formatting the memory card.

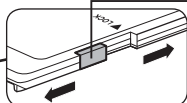
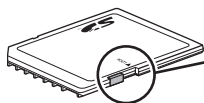

Write protect switch

Basic Setup

A language-selection dialog is displayed the first time the camera is turned on. Select a language and set the time and date as described below.



The multi selector is used in the following steps. The buttons needed to perform a task in each step are shown in white. For example, "Press **OK**" is shown at left.

1



Confirm that screen above is displayed on monitor.

2



Highlight language.

3

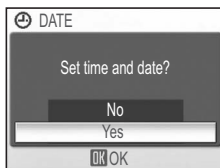

Confirmation dialog is displayed.

4



Highlight **Yes**.

5



TIME ZONE menu is displayed.

- To turn daylight saving time on or off, see "Note on Daylight Saving Time" (P.23) for details.

6



Display map of world time zones.

7



Select home time zone.

8

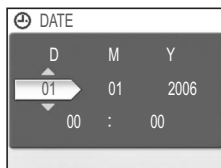

Display **DATE** menu.
The selected item blinks.

9

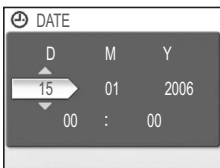

Edit **Day** (order of **Day**, **Month**, and **Year** may differ in some areas).

10

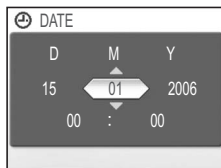

Select **Month**.

11

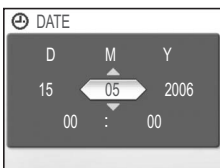

Edit **Month**.

- Repeat steps 10 and 11 to edit **Year**, **hour**, and **minute**.

12

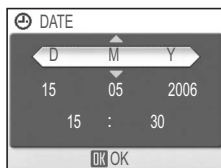

Highlight **D M Y**.

13

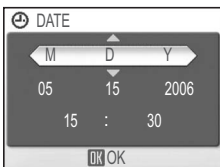

Select date display order.

14

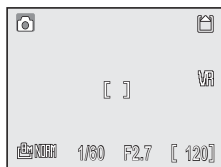

Exit **DATE** menu. Camera is now ready for use.

Note on Daylight Saving Time

To turn daylight saving time on or off, press the multi selector down to highlight **DaylightSaving** and press in step 5. When **DaylightSaving** is checked, the time will automatically be advanced one hour.

Basic Photography and Playback

Mode

This section describes how to take pictures in  (Auto shooting) mode, an automatic, “point and shoot” mode recommended for first-time users of digital cameras.

Step 1. Select mode.

1

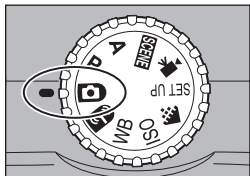

Rotate mode dial to .

Step 2. Turn camera on.

2.1

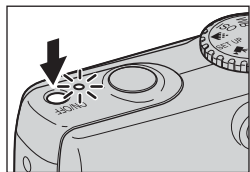

Turn camera on.

The power-on lamp will light and the monitor will turn on.

2.2

Check battery level and number of exposures remaining.

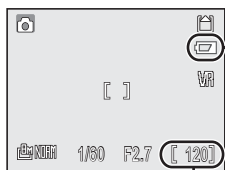

Number of exposures remaining

No icon	Battery is fully charged.
	Battery is low. Charging the battery is recommended.
WARNING!! BATTERY EXHAUSTED	Battery is exhausted. Charge the battery.

Turning the Camera Off

After pressing the power switch to turn the camera off, the power-on lamp will go out.

For more information, see “Image Quality/Size and Number of Exposures Remaining” (P.145).

Step 3. Frame picture.

3.1

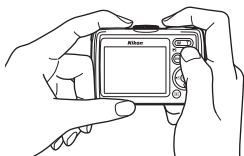

Ready camera.

Hold the camera steady, keeping your fingers and other objects away from the lens, flash window, AF-assist illuminator, and microphone.

3.2

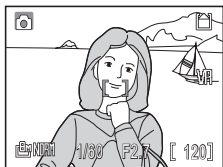

Frame picture.

Frame the subject near the center of the monitor.



Zoom

Press the zoom buttons to activate the optical zoom and frame the subject on the monitor.

- Press **W** to zoom out, increasing the area visible in the frame. Press **T** to zoom in to make the subject appear larger.
- When the camera is zoomed in to the maximum magnification (3.5x) in optical zoom, holding **T** down for approximately two seconds will trigger digital zoom. The subject is magnified up to 4x, for a total of magnification of 14x.
- Digital zoom simply enlarges the center area of the picture to fill the frame using a digital process and may produce a slightly grainy image, while optical zoom increases the amount of visible details.
- An indicator on the monitor shows the amount of zoom when zoom buttons are pressed.
- The zoom indicator will turn yellow when digital zoom is in effect.
- To cancel digital zoom, press **W** until the zoom indicator turns white.

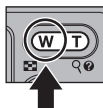

Zoom out

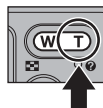

Zoom in

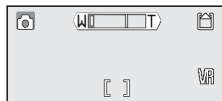

Auto Off



If no operations are performed for approximately one minute (default setting), the camera enters Standby mode to save power. In Standby mode, the monitor turns off and the power-on lamp blinks. To reactivate the camera, press the shutter-release button halfway. If no operations are performed in Standby mode for another three minutes, the camera turns off (P.105, 149).

Step 4. Focus and shoot.

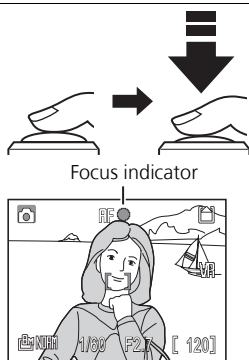
4.1



Press shutter-release button halfway.

- Lightly press the shutter-release button halfway, stopping when you feel resistance. Focus and exposure are set and locked while the shutter-release button is held in this position.
- In  mode, the camera focuses on the subject at the center of the frame (P.86). When the subject is in focus, the focus indicator  and focus area [] will be outlined in green. When the camera is unable to focus, the focus indicator and focus area will blink red. Change the composition and try again.



4.2



Press shutter-release button the rest of the way down to take picture.

- The flash may fire if the subject is poorly lit (P.28).



Note on Recording

When the  icon is displayed or the memory icon ( or ) is blinking, pictures are being stored. Removing the memory card or battery while recording may affect pictures or damage the camera or card.

AF-Assist Illuminator

If lighting is poor, the built-in AF-assist illuminator will light when the shutter-release button is pressed halfway, allowing the camera to focus on the subject (P.104).

Available Functions in Auto Shooting Mode

Flash, self-timer, focus, and exposure compensation can be set (P.28, 30, 31, 32) in  mode. **Image quality** and **Image size** (P.43) can also be changed when the mode dial is set to  mode.

For more information, see "Getting Good Results with Autofocus" (P.147).

Viewing Pictures

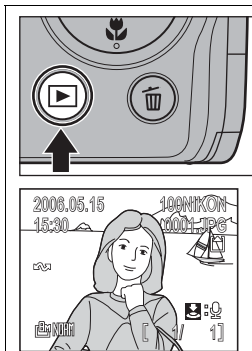

Press  to display picture on monitor.

- To view additional pictures, press the multi selector down or right to view pictures in the recorded order, and up or left to view pictures in reverse order. To scroll quickly through your pictures, press and hold the multi selector.
- Pictures may be displayed briefly at low resolution while being read from memory.
- Press  again to return to Shooting mode.



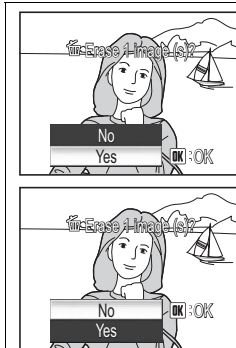

Deleting Pictures





Press  to delete current picture.

A confirmation dialog is displayed. Highlight **Yes** and press  to delete the picture.





- Highlight **No** and press  to return to the Playback screen without deleting the picture.
- Pressing  in Shooting mode deletes the last picture taken.

Turning Camera On with

When the camera is off, pressing  for approximately one second will turn the camera on in Full-screen playback mode (P.49). Press  again to return to the mode previously selected with the mode dial.

Using the Flash

The following five flash modes are available:

Mode	Description	When to use
 Auto (default setting)	Flash fires automatically when lighting is poor.	Best choice for most situations.
 Auto with red-eye reduction	Pre-flashes are fired several times at low-intensity before the main flash to reduce “red-eye”. If “red-eye” is detected after a picture is taken, the camera will correct “red-eye” when storing the picture.	<ul style="list-style-type: none">• Use for portraits (works best when the subject is within range of the flash and looking at the pre-flashes).• Not recommended when quick shutter response is required.
 Flash Cancel (off)	Flash will not fire even when light levels are low.	Use to capture natural lighting under dim light or where use of the flash is prohibited.
 Anytime Flash (fill flash)	Flash fires whenever a picture is taken.	Use to lighten dark shadows and for back-lit subjects.
 Slow sync	Flash fires automatically and a picture is taken with a slow shutter speed.	Use to capture both the subject and background at night or under dim light.

Red-Eye Reduction

Pre-flashes are fired several times at low-intensity before the main flash to reduce “red-eye”. If the camera detects “red-eye” after a picture is taken, *advanced red-eye reduction* will further reduce “red-eye” when storing the picture. Using this function, there is slight delay before you can press the shutter-release button again for the next shot.

Select another flash mode in the following cases:

- When quick shutter response is required.
- When red-eye reduction does not produce the desired results.
- In rare cases when other picture areas may be affected as well as the “red-eye” area.

Flash Range

- When **SENSITIVITY** is set to **Auto**:
Zoom out : Approx. 0.4 - 4.0 m (1 ft. 4 in. - 13 ft. 1 in.)
Zoom in : Approx. 0.4 - 2.0 m (1 ft. 4 in. - 6 ft. 7 in.)
- The flash may not be able to light the entire subject at distances of less than 0.4 m (1 ft. 4 in.).
When taking close-ups, check the results after each shot.

Selecting the Flash Option

1

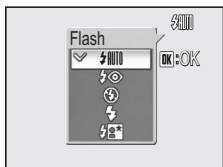

Display **Flash** menu.

2

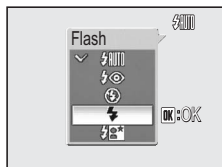

Highlight option.

3



Selected flash option is indicated by icon on monitor.

- To exit without changing the flash mode, wait five seconds without pressing **OK**.

✓ Note on Using the Flash

When taking flash pictures at a wide-angle zoom position, bright reflections from dust particles in the air may appear in the picture as bright spots. To reduce these bright reflections, set the flash to **Flash Cancel** or zoom in on the subject.



Checking the Flash Status

The flash lamp and flash indicator (P.14) on the monitor show the flash status when the shutter-release button is pressed half-way.

- On** : The flash fires when a picture is taken.
- Blinks** : The flash is charging. Wait until the lamp stays on.
- Off** : The flash will not fire when a picture is taken.

Flash lamp

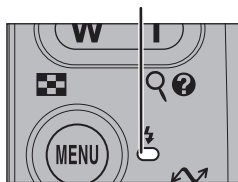

Taking Pictures with the Self-Timer

The self-timer allows you to appear in your own pictures.

When using the self-timer, mount the camera on a tripod (recommended) or rest it on a flat, level surface.

1

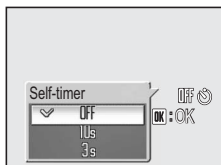

Display **Self-timer** menu.

2

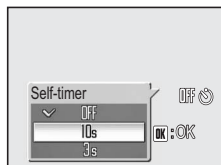

Highlight option.

3

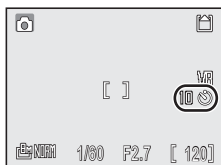

☺ icon is displayed on monitor.

- To exit without setting the self-timer, wait five seconds without pressing .

4

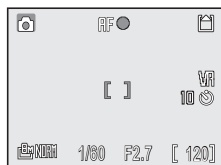

Set focus and exposure.

Press the shutter-release button halfway to set.

5

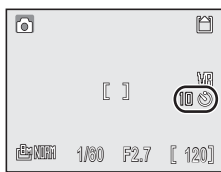

Press shutter-release button the rest of the way down to start timer.

- Pictures are taken 3 or 10 seconds after the shutter-release button is pressed.
- The countdown timer on the monitor turns yellow and shows the number of seconds remaining until the shutter is released.
- Press the shutter-release button again to stop the self-timer.

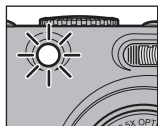



- The self-timer lamp will blink until one second before the picture is taken, and will stay lit during the final second to warn that the shutter is about to be released.

Selecting Focus Option

The following four options are available:

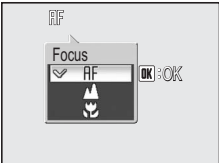
Mode	Description	When to use
AF Autofocus (default setting)	The camera automatically adjusts the focus according to the distance to the subject.	Use when subject is 30 cm (1 ft.) or more from the lens at a wide-angle zoom position.
▲ Infinity	The camera focuses on subjects from 5 m (16 ft. 5 in.) to infinity.	Use when shooting distant scenes through foreground objects such as windows.
▲ Focusing limit	The camera can focus on subjects from 2 m (6 ft. 7 in.) to infinity.	Use when subject is 2 m (6 ft. 7 in.) or further from the lens. The camera will focus faster than when set to Autofocus. Available only when the mode dial is set to P or A .
🌸 Macro close-up	When the 🌸 icon on the shooting display turns green and the zoom position is set to wide-angle, the camera can focus on objects as close as 4 cm (1.7 in.) from the lens.	Use for close-ups.

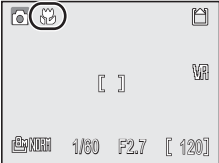
1  Display Focus menu.	 2  Highlight option.
3  	<p>Selected focus option is indicated by icon on monitor.</p> <ul style="list-style-type: none"> To exit without setting the focus mode, wait five seconds without pressing OK.

Note on Focus Option

Focus option cannot be selected in some scene modes (P.33 - 40).

Exposure Compensation

Exposure compensation is used to alter the exposure from the value suggested by the camera. Exposure compensation can be set to values between -2.0 EV* (underexposure) and $+2.0$ EV (overexposure) in increments of $1/3$ EV.

1

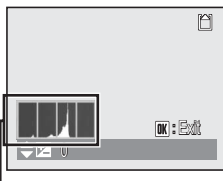

Histogram

Display exposure compensation setting screen.

The histogram (which shows the range of brightness) and exposure compensation value are displayed.

2

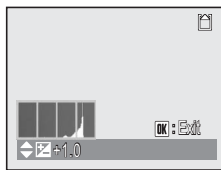

Select value.

- You can frame your subject, focus, and shoot.
- Press **OK** to exit.

* Exposure value



Selecting an Exposure Compensation Value

- The camera tends to shorten exposures when the large areas of the frame are very bright (for example, when photographing an expanse of sunlit water, sand, or snow) or the background is much brighter than the main subject.
Select *positive* values if the main subject looks too dark.
- The camera tends to give more exposure when the large areas of the frame are very dark (for example, when photographing a forest of dark green leaves) or when the background is much darker than the main subject.
Select *negative* values if the main subject looks too bright, or “washed out”.



Histogram

A histogram shows the distribution of brightness in an image; the horizontal axis shows pixel brightness, with dark tones to the left and bright tones to the right, while the vertical axis shows the number of pixels in the image at each tonal value. The more pixels appear on the left, the darker the image. The more pixels appear on the right, the brighter the image.

Selecting Scene Mode

Scene Mode

You can select from a menu of 16 “scenes”, each corresponding to a particular situation. Camera settings are automatically adjusted to suit the selected scene, sparing you the necessity of adjusting each setting separately. Selecting the Advanced option allows 3 effects, **Normal**, **Effect 1**, and **Effect 2**, to be selected for 9 of the 16 scenes. For example, you can adjust an image in **PORTRAIT** to make skin tones appear brighter.

Selecting a Scene

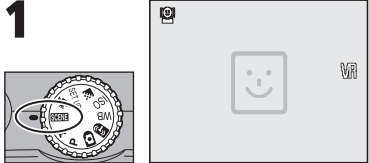
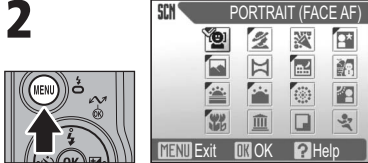
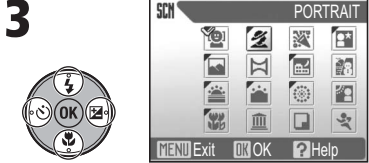
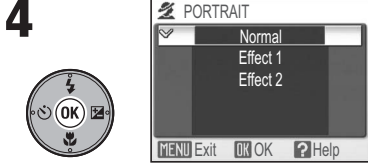
<p>1</p>  <p>Rotate mode dial to SCENE.</p> <ul style="list-style-type: none">• Default setting is PORTRAIT (FACE AF).	<p>2</p>  <p>Display Scene menu.*</p>
<p>3</p>  <p>Highlight scene.</p> <ul style="list-style-type: none">• To exit without changing the current selection, press MENU.	<p>4</p>  <p>Display Advanced options menu.</p> <ul style="list-style-type: none">• If there are no options, the selected scene mode is set and the screen returns to Shooting mode. The selected scene is indicated by an icon on the top left corner of the monitor.

* The menu option set most recently appears selected.

5

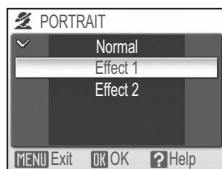

Highlight option.

6

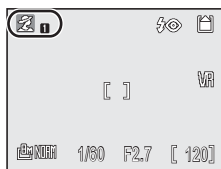

Set option and return to Shooting mode.

- If Advanced option is set to **Effect 1** or **Effect 2**, the selected effect (1 or 2) appears next to the scene mode icon.

Advanced Options Effects

You may not be able to check the Advanced options effects on the monitor while shooting. To see the results, play back the picture.

Available Scene Modes

PORTRAIT (FACE AF)

Use for portraits (from the waist up) of up to three people. When the camera recognizes human faces, a square focus area is displayed and the subject is in focus (Face-priority AF).

See page 39 for more information on how to take pictures with this function.

Effect 1: Skin tones appears brighter, causing faces to stand out.

Effect 2: Softens the overall image.

- Digital zoom is not available.



PORTRAIT

Use for portraits. The main subject stands out clearly while the background details are softened, lending a sense of depth to the composition.

Effect 1: Skin tones appears brighter, causing faces to stand out.

Effect 2: Softens the overall image.

- Digital zoom is not available.



PARTY/INDOOR

Captures the effects of candlelight and other indoor background lighting.

- In dimly lit surroundings, turn Vibration reduction (P.48) on and hold the camera steady to prevent camera shake.



NIGHT PORTRAIT

Use for a natural balance between the main subject and background lighting in portraits shot at night.

Effect 1: The subject and background are captured more vividly.

Effect 2: Point sources of light radiate out and cause the night-scape to stand out.

- Noise reduction turns on automatically at slow shutter speeds and it will take longer than usual to store the picture.
- Digital zoom is not available.
- To prevent blurring, mount the camera on a tripod or rest it on a flat, level surface.



Note on Using a Tripod

Turn Vibration reduction (P.48) off when using a tripod.

For more information, see “Settings for Scene Mode” (P.146).

 **LANDSCAPE**

Use for vivid landscape shots that enhance outlines, colors, and contrast in such subjects as skylines and forests.

Effect 1: Colors are enhanced, causing the landscape to appear more vivid and clear.

Effect 2: The blue color of the sky is captured more vividly.

- The camera focuses at infinity. The focus indicator lights whenever the shutter-release button is pressed halfway.

 **PANORAMA ASSIST**

Use when taking a series of pictures that will later be joined to form a single scene (for example, a panorama or 360° virtual-reality image).

See page 40 for more information on how to take pictures with this function.

- Settings for the flash, self-timer, focus, zoom, and exposure are determined by the first shot in each series.
- Using a tripod makes it easier to compose overlapping shots.

 **NIGHT LANDSCAPE**

Slow shutter speeds are used to produce stunning nightscapes.

Effect 1: Nightscapes are captured more vividly.

Effect 2: Point sources of light radiate out and cause the night-scape to stand out.

- The camera focuses at infinity. The focus indicator lights whenever the shutter-release button is pressed halfway.
- Noise reduction turns on automatically at slow shutter speeds and it will take longer than usual to store the picture.
- To prevent blurring, mount the camera on a tripod or rest it on a flat, level surface.

 **BEACH/SNOW**

Captures the brightness of such subjects as snowfields, beaches, or sunlit expanses of water.



SUNSET

Preserves the deep hues seen in sunsets and sunrises.

Effect 1: Red hues are captured more vividly.

Effect 2: The colors of the sunset and sunrise are captured more realistically.

- The camera focuses at infinity. The focus indicator lights whenever the shutter-release button is pressed halfway.
- In dimly lit surroundings, turn Vibration reduction (P.48) on and hold the camera steady to prevent camera shake.

**DUSK/DAWN**

Preserves the colors seen in the weak natural light before sunrise or after sunset.

Effect 1: Blue colors are captured more vividly.

Effect 2: The colors of the landscape are captured more realistically.

- The camera focuses at infinity. The focus indicator lights whenever the shutter-release button is pressed halfway.
- Noise reduction turns on automatically at slow shutter speeds and it will take longer than usual to store the picture.
- To prevent blurring, mount the camera on a tripod or rest it on a flat, level surface.

**FIREWORKS SHOW**

Slow shutter speeds are used to capture the expanding burst of light from fireworks.

Effect 1: Continuous, simultaneous fireworks are captured clearly.

Effect 2: Large fireworks that burst slowly are captured along with their trail.

- The focus is fixed at infinity. The focus indicator lights whenever the shutter-release button is pressed halfway.
- Exposure compensation is not available.
- To prevent blurring, mount the camera on a tripod or rest it on a flat, level surface.

**BACK LIGHT**

Use when a portrait subject's face is thrown into shadow due to light coming from behind.

**Note on Using a Tripod**

Turn Vibration reduction (P.48) off when using a tripod.

🌸 CLOSE UP

Photograph flowers, insects, and other small objects at close range.

Effect 1: The subject is captured more vividly and clearly.

Effect 2: Background details are softened and shutter speeds are faster. Optimal for freezing moving subjects such as flowers swaying in the breeze.

- The zoom position is automatically set to wide-angle and the 🌸 icon on the monitor turns green.
- The camera can focus on objects as close as 4 cm (1.7 in.) from the lens at a wide-angle zoom position.
- Minimum focus distance will vary with the zoom position.
- The camera focuses continuously until the focus is locked by pressing the shutter-release button halfway.
- Select from 99 areas to focus on in the focus area using the multi selector.
- Turn Vibration reduction (P.48) on and hold the camera steady to prevent camera shake.



🏛️ MUSEUM

Use indoors where flash photography is prohibited (for example, in museums and art galleries) or in other settings where you do not want to use the flash.

- Best Shot Selector (P.82) turns on automatically, reducing the effects of inadvertent camera movement.
- Photography may be prohibited altogether in some locations. Be sure to obtain permission first.
- In dimly lit surroundings, turn Vibration reduction (P.48) on and hold the camera steady to prevent camera shake.



📄 COPY

Provides clear pictures of black and white text or drawings on a white board or in print. Additionally, use when taking black and white pictures.

- Colored text and drawings may not show up well in the final picture.

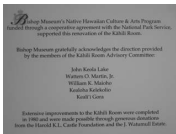

🏃 SPORTS

Fast shutter speeds freeze fast-moving subjects for dynamic sports scenes.

- The camera focuses continuously until the focus is locked by pressing the shutter-release button halfway.
- While the shutter-release button is fully pressed, the camera shoots at approximately 1.8 frames per second.
- Settings for the focus, exposure, and auto white balance are determined by the first shot in each series.



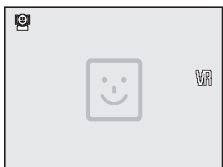

Using PORTRAIT (FACE AF) Mode

1





Rotate mode dial to **SCENE**.

- Default setting is  **PORTRAIT (FACE AF)**. If you have already selected a different scene, press **MENU** to select .
 blinks in the center of the monitor.

2



Frame picture using size of  as a guide.

- When the subject's face becomes the same size as , the camera recognizes it and frames with a double yellow border.
- If the camera detects multiple faces, the closest will be framed by a double border, the rest by a single border. The camera can recognize up to three faces.
- If the camera can no longer detect the subject (for example, because the subject has looked away from the camera), borders will no longer be displayed and  will blink on the monitor (screen in step 1).

3

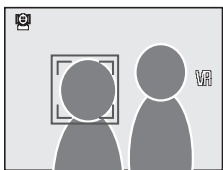

Press shutter-release button halfway to set focus and exposure.

The double border turns green.

4

Press shutter-release button the rest of the way down to take picture.

Taking Pictures with Face-priority AF

- The camera focuses continuously until the focus and exposure are locked by pressing the shutter-release button halfway. If no face is detected when the shutter-release button is pressed halfway, the camera will focus on the center of the frame.
- Digital zoom (P.25) is not available.
- The camera's ability to detect faces depends on a variety of factors, including whether or not the subject is facing the camera. The camera may be unable to detect faces that are partially hidden by sunglasses or other obstructions, or faces that take up too much or too little of the frame.

Using PANORAMA ASSIST Mode

1



Highlight  (**PANORAMA ASSIST**) in Scene menu.

2



Compose first shot.

3

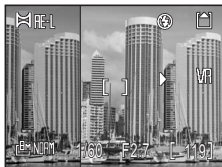

Take first shot.

- The **AE-L** icon is displayed and approximately 1/3 of the picture is shown super-imposed.
- Settings for white balance and exposure are determined by the first shot.

4



Take next shot.

Compose the next shot to overlap with the previous picture.

5



Take next shot.

Repeat steps 4 and 5 until all shots in the series have been taken.

6



End series.

- Shooting will also end by changing the mode or entering Standby mode.



Note on Panorama Assist

Settings for the flash, self-timer, focus, exposure, and zoom position cannot be adjusted after the first picture is taken.

Additional Shooting Options

Using Exposure Control

Two types of Exposure modes **P** (Programmed auto) and **A** (Aperture-priority auto) are available. **P** and **A** modes also allow you to control ISO Sensitivity (P.45), white balance (P.46), and the options in the Shooting menu (P.78).

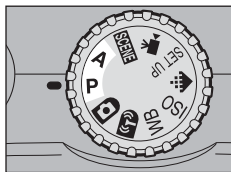

Mode	Description	When to use
P Programmed auto	Sets shutter speed and aperture for optimal exposure. "Flexible program" can be used to select additional combinations of shutter speeds and apertures that will produce the correct exposure.	Recommended for most situations.
A Aperture priority auto	You select the aperture and the camera sets the shutter speed for the best exposure.	Use to vividly capture the main subject and background or to soften the background details

P Programmed Auto

<p>1</p> <p>Rotate mode dial to P.</p>	<p>2</p> <p>Frame picture, focus, and shoot.</p>
------------------------------------------------------	---------------------------------------------------------

Flexible Program

- In **P** mode, different combinations of shutter speeds and apertures can be selected by pressing the multi selector right (Flexible program). Then, press the multi selector left to decrease the shutter speed and right to increase the shutter speed. While Flexible program is in effect, the shutter speed and aperture are displayed in yellow (otherwise, they are displayed in white).
- When returned to Shooting mode, an asterisk ("*") appears next to **P** and the set values of the shutter speed and aperture also appear.
- To deactivate Flexible program, press the multi selector left or right until the shutter speed and aperture are displayed in white, or rotate the mode dial to a different setting. Turning the camera off also deactivates Flexible program.

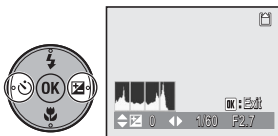

A Aperture Priority Auto

1

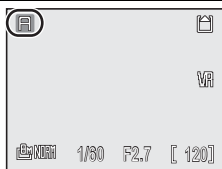

Rotate mode dial to **A**.

2

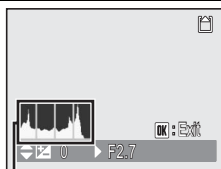

Histogram

Display exposure compensation setting screen.

The histogram (which shows the distribution of brightness) and exposure compensation value are displayed.

3

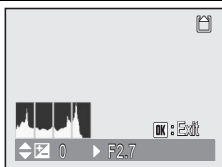

Set aperture.

- Press **OK** to return to the Shooting mode.

4



Frame picture, focus, and shoot.



Aperture and Zoom

The aperture value (measured in *f*-numbers) expresses the amount of light that passes through the lens and is calculated by dividing the lens' focal length by the effective diameter (a value based on the physical opening in the lens and the amount of light passing through). Lower *f*-numbers indicate an increase in the amount of light passing through and higher *f*-numbers indicate a decrease. The smallest number in a lens' aperture range is the maximum aperture and the largest number is the minimum aperture.

The aperture for this camera's lens (focal length: 7.5 to 26.3 mm; aperture range: *f*/2.7 to *f*/5.3) changes depending on the zoom setting. The aperture increases when zooming in and decreases when zooming out.

- Selecting **On** for **Fixed aperture** (P.88) in **A** (Aperture-priority auto) mode keeps the aperture change as close as possible to the selected *f*-number (aperture range: *f*/5 to *f*/7.3).
- In **P** (Programmed auto) mode, **Fixed aperture** has no effect even if set to **On**.

Selecting Image Quality and Size

The image quality and size you select determine the file size of a picture when stored in the internal memory or on the memory card.

Image Quality

The process of reducing the image file size when storing is called compression.

In this camera, pictures are compressed and recorded as JPEG files. The more a picture is compressed, the smaller the image file size becomes. As a result, more pictures can be stored in the internal memory or on the memory card. However, the image quality, compared with a picture taken with a lower compression ratio, decreases and pictures cannot be printed at large sizes without a loss of quality.

The less a picture is compressed, the larger the image size becomes. As a result, fewer pictures can be stored in the internal memory or on the memory card. However, less compression increases the image quality.

Image Size

Larger pictures create larger image files and are suitable for printing in large size. However, fewer pictures can be stored in the internal memory or on the memory card.

Smaller pictures create smaller image files and are more suitable for transmission by e-mail or for use on web pages.

When printed in larger sizes, however, small images will look rough and uneven in appearance.

For more information, see "Image Mode and Number of Exposures Remaining" (P.144).

Selecting Image Quality or Size

1



Rotate mode dial to . **IMAGE MODE** menu is displayed.

2

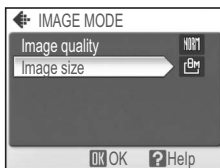

Highlight **Image quality** or **Image size** and press **OK**.

3

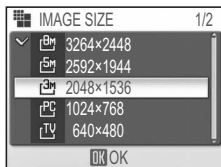

Highlight option and press **OK**.

4

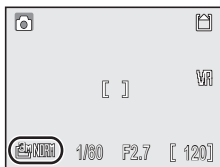

Rotate mode dial to , **SCENE**, **P**, **A** or (when **Shoot & Transfer** is selected).

The current image quality and size are displayed on the monitor.



Image Quality or Size in the Shooting Menu

Image quality and size can also be set in the Shooting menu (P.78).

Using ISO Sensitivity

ISO Sensitivity is a measure of how the camera's sensor reacts to light. Setting a high ISO will let you take pictures with smaller apertures under low lighting conditions or make it easier to freeze action with faster shutter speeds. However, the higher the ISO, the more likely "noise" in the form of randomly-spaced, brightly-colored pixels may appear.

ISO Sensitivity can be selected in **P** and **A** modes.

Setting ISO Sensitivity

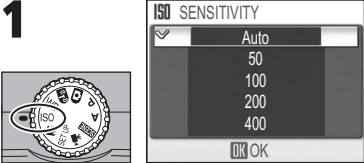
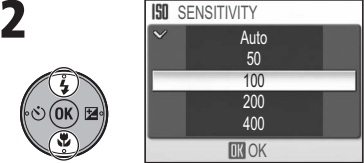
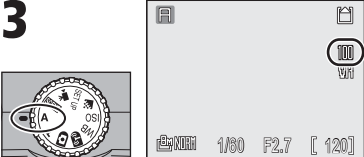
<p>1</p>  <p>Rotate mode dial to ISO. SENSITIVITY menu is displayed.</p>	<p>2</p>  <p>Highlight option and press OK.</p>
<p>3</p>  <p>If ISO Sensitivity is set to an option other than Auto, rotate mode dial to P or A. The current setting is shown in the shooting display.</p>	

✓ ISO Sensitivity Setting When Using Flash

A setting of **400** is intended for use with natural lighting. Select **Auto**, **50**, **100**, or **200** when using the flash (P.28).



Setting ISO Sensitivity from the Shooting Menu

ISO Sensitivity can also be set using the **Sensitivity** option in the Shooting menu (P.78).

For more information, see "Options for ISO Sensitivity" (P.149).

Setting White Balance

Adjust the white balance based on the light source to give the image the most realistic colors possible. **Auto** (default setting) will cover most situations, but the white balance may be changed to compensate for unusual lighting conditions that may produce images with unnatural colors.

White balance can be selected in **P** and **A** modes.

Selecting a White Balance Setting

1

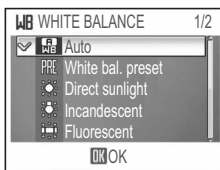
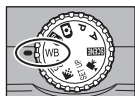

Rotate mode dial to **WB**.
WHITE BALANCE menu is displayed.

2

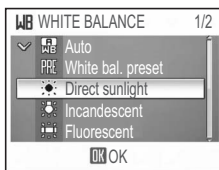

Highlight option and press **OK**.

3

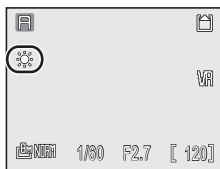

If white balance is set to an option other than **Auto**, rotate mode dial to **P** or **A**.
The current setting is shown in the shooting display.

✓ Settings Other than Auto or Flash

When setting White balance to a setting other than **Auto** or **Flash**, set the flash to  (Flash Cancel) (P.28).



Setting White Balance from the Shooting Menu

White balance can also be set using the **White balance** option in the Shooting menu (P.78).

For more information, see "Options for White Balance" (P.149).

Preset White Balance

Preset white balance is used when shooting under mixed lighting or to compensate for light sources with a strong color cast (for example, to make pictures taken under an incandescent light look as though they had been taken under white light).

When **White bal. preset** is selected in the **WHITE BALANCE** menu, the camera will zoom in and the menu shown at right will be displayed on the monitor.



White balance measuring window

Cancel (default setting)	Maintains the most recent value and uses it for white balance.
Measure	To measure a new value for white balance, place a neutral gray object, such as a piece of cardboard, under the lighting that will be used when shooting. Frame the object to fill the square in the center of the menu shown above. Highlight Measure and press OK to measure a new value for white balance (the shutter will be released and the camera will return to the original zoom position, but no picture will be recorded).

✓ Notes on Preset White Balance

- The camera cannot measure a value for preset white balance when the flash fires. Regardless of the flash mode selected, the flash will not fire when selecting **Measure**.
- Preset white balance cannot be used when **AUTO BRACKETING** is set to **WB bracketing**.
- If the mode dial is set to **WB**, the lens does not extend when turning the camera on. The lens extends only after pressing **OK** when you select **White bal. preset** in the **WHITE BALANCE** menu.

Using Vibration Reduction (VR)

Vibration reduction adjusts the lens to compensate for camera motion that can blur your image while shooting still pictures or movies. It makes blurring less likely to occur in situations where it is difficult to hold the camera steady, such as when shooting at slow shutter speeds in dimly lit surroundings or when zoomed in for close-up shots. When you compose your image, you can see the results of Vibration reduction on the camera's monitor.

VR Normal (default setting)	Suitable for normal shooting conditions. The camera detects and smoothes out panning movements. Vibration reduction reduces only vertical shake when the camera is panned horizontally and only horizontal shake when panned vertically.
VR-ACTIVE Active	Suitable for severe camera shake such as when shooting from a moving vehicle. This option does not detect vibrations when panning.
Off	Vibration reduction is turned off.

Setting Vibration Reduction

1

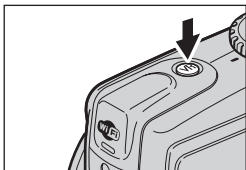

In Shooting mode, press **VR** repeatedly to select **VR** (Normal), **VR-ACTIVE** (Active) or Off.

2

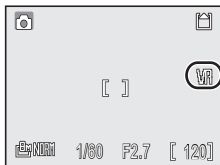

Selected option is indicated by icon on monitor.

- After the icon appears, frame picture, focus, and shoot.



Notes on Vibration Reduction

- Vibration reduction may take a few seconds to activate after the camera recovers from Standby mode or the power is turned on. Wait until the display stabilizes before shooting. There may also be a slight display lag after a picture is taken.
- Turn Vibration reduction off when using a tripod.
- Depending on the situation, camera shake may not be completely reduced even if Vibration reduction is set.







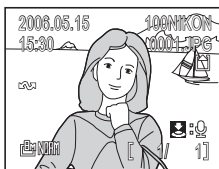

Viewing Pictures on the Camera

Full-screen Playback Mode

Press  in Shooting mode to view pictures in Full-screen playback mode.

The following operations can be performed in this mode.



View next picture		–
View previous picture		–
Delete picture		P.27
Zoom in		P.52
View thumbnails		P.50
View Playback menu	MENU	P.76
Record/Play voice memo	Shutter-release button	P.55
View histogram display (for still pictures)		P.51
Play movie (for movies)		P.60
Exit to Shooting mode		–



Viewing Pictures





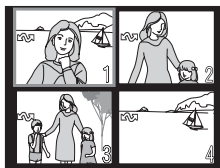

- When the camera is off, pressing  for approximately one second will turn the camera on in Full-screen playback mode.
- To view the pictures in the internal memory, remove the memory card.

Viewing Multiple Pictures: Thumbnail Playback

Pressing  (**W**) in Full-screen playback mode (P.49) displays pictures in "contact sheets" of 4, 9 or 16 thumbnail images.



The following operations can be performed in Thumbnail playback mode.



Highlight picture		—
Change number of pictures displayed	 (W) /  (T)	—
Delete highlighted picture		P.27
Exit to Full-screen playback mode		P.49
View Playback menu	MENU	P.76
Exit to Shooting mode		—



Thumbnail Playback

- Press  (**W**) or  (**T**) in Thumbnail playback mode to switch between the 4, 9 and 16 thumbnail display.
- To exit to Full-screen playback mode, press  (**T**) in the 4 thumbnail display.

Histogram Display

Press **OK** in Full-screen playback mode (P.49) to view the histogram display. The following settings appear on the right side of the display:

- Shooting mode (**P/A**)
- Shutter speed
- Aperture
- Exposure compensation
- ISO Sensitivity

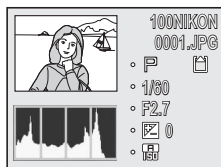

View histogram of next picture		–
View histogram of previous picture		–
Delete picture		P.27
View thumbnails	(W)	P.50
Exit to Full-screen playback mode		P.49
View Playback menu	MENU	P.76
Exit to Shooting mode		–

Deleting Pictures

Pressing in Full-screen or Thumbnail playback mode displays the dialog shown at right. Highlight **Yes** and press **OK** to delete the selected picture.

- : Delete the voice memo only (P.55). is displayed only when selecting a picture with a voice memo.

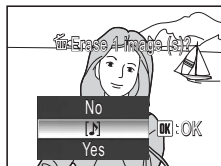

Taking a Closer Look



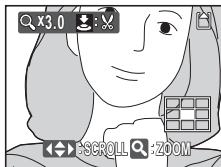

Quick Playback Zoom

Press **Q** (**T**) in Full-screen playback mode (P.49) to activate Quick playback zoom and display an enlarged (approximately 3x) part of the picture.

- The center area of the picture is enlarged but other areas of the picture may also be viewed.
- The location of the area viewed in relation to the full image is displayed on a 3 × 3 navigation grid in the lower right hand corner of the screen.



The following operations can be performed in Quick playback zoom.

Switch to Playback zoom mode	 (W)/ Q (T)	P.53
View other areas of picture		–
Delete picture		P.27
View Playback menu	MENU	P.76
Exit to Full-screen playback mode		P.49
Crop picture	Shutter-release button	P.54
Exit to Shooting mode		–

Playback Zoom

While Quick playback zoom is in effect, press **Q (T)** or **W** to zoom the picture in or out. Pictures can be zoomed in to a maximum of 10x.

- When an image is zoomed in on, the zoom ratio is displayed on the monitor.

The following operations can be performed while pictures are zoomed in.

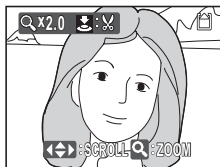





Zoom in	Q (T)	–
Zoom out	W	–
View other areas of picture		–
Delete picture		P.27
View Playback menu	MENU	P.76
Exit to Full-screen playback mode	OK	P.49
Crop picture	Shutter-release button	P.54
Exit to Shooting mode		–

Playback Zoom



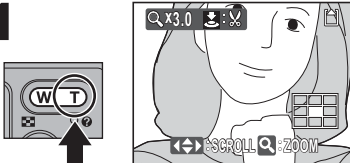
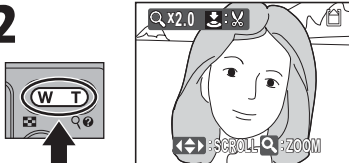



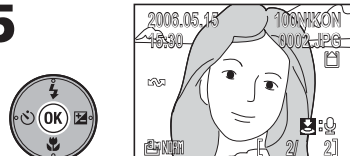

Playback zoom is not available with movies (P.58), copies created using the **Small pic.** option (P.96), or cropped copies of 320 × 240 pixels or smaller (P.54).

Creating a Cropped Copy

When the  icon is displayed in Quick playback zoom (P.52) or Playback zoom mode (P.53), you can crop part of a picture and save it as a separate file.

<p>1</p>  <p>Zoom in on picture. Press Q (T) to activate Quick playback zoom.</p>	<p>2</p>  <p>Display desired portion of image.</p> <ul style="list-style-type: none">• Press Q (T) or  (W) to zoom the picture in and out.• Use the multi selector to scroll the picture until the desired portion of the image is displayed.
<p>3</p>  <p>Confirmation dialog is displayed.</p>	<p>4</p>  <p>Highlight Yes.</p>
<p>5</p>  <p>Cropped copy is created.</p>	

✓ Cropping pictures

Depending on the size of the original picture and the zoom ratio at the time the copy was created, copies will be  3,264 × 2,448,  2,592 × 1,944,  2,048 × 1,536,  1,600 × 1,200,  1,280 × 960,  1,024 × 768,  640 × 480,  320 × 240, or  160 × 120 pixels in size.

Voice Memos

A voice memo can be recorded using the built-in microphone and appended to any picture marked with the  (voice memo recording guide) icon in Full-screen playback mode (P.49).

Recording Voice Memos

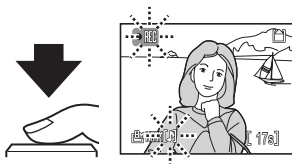

Press and hold the shutter-release button to record a voice memo. Recording ends after approximately 20 seconds or when the button is released.

- Do not touch the microphone during recording.
- The  icon blinks during recording.





Playing Back Voice Memos

Select a picture with a recorded voice memo and press the shutter-release button to play it back. Playback ends when the voice memo ends or the shutter-release button is pressed again.

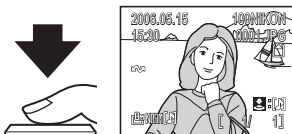
- Pictures with voice memos are marked with the  icon in Full-screen playback mode.
- Press  (W) or  (T) to adjust the volume.



Deleting Voice Memos

Select a picture with a recorded voice memo and press . Highlight  and press  to delete the voice memo only.

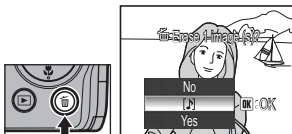





Notes on Voice Memos

- Voice memo file names are the same as those of the images they attach to except that the extension is “.WAV”.
- If a voice memo is already appended to the current picture, delete the memo first to record a new voice memo.

Selecting Movie Options

Selecting Movie Options

Select the type of movie according to your shooting intent.

Mode	Size (pixels)	Frame/sec
 TV movie 640 (default setting)	640 × 480	30
 Small size 320	320 × 240	30
 Smaller size 160	160 × 120	30
 Time-lapse movie	640 × 480	30

1

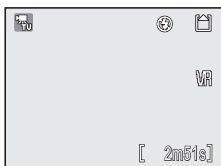

Rotate mode dial to .

2



Movie menu is displayed.

3



Highlight **Movie options**.

4



MOVIE OPTIONS menu is displayed.

5



Highlight option.

- Press the multi selector left to return to the previous screen.

6

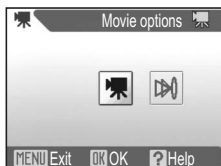

Set option and return to Movie menu.

7

Return to Movie shooting screen.

Selecting Auto-Focus Mode





Auto-focus mode can be selected when shooting movies. Select **Auto-focus mode** in the Movie menu, and select one of the following two modes.

AF Single AF (default setting)	The camera focuses on the center of the frame when the shutter-release button is pressed halfway. Focus locks (AF Lock) when the focus operation is complete (P.87). The focus will remain locked while shooting movies.
AF Full-time AF	The camera adjusts focus continuously. Select Single AF if the sound of the camera focusing interferes with recording.

For more information, see "Movie Options and Maximum Total Recording Time" (P.145).

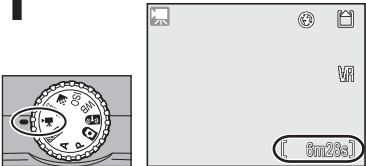
Recording Movies

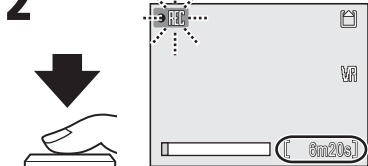
Movies are recorded with sound via the camera's built-in microphone as QuickTime files with the extension ".MOV". The files can be played back on a computer after transfer.

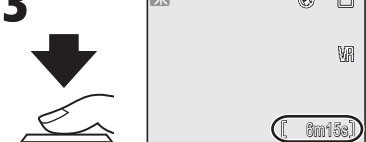

<p>1</p>  <p>Rotate mode dial to .</p> <p>The monitor shows the available recording time.</p>	<p>2</p>  <p>Start recording.</p> <ul style="list-style-type: none">• The camera focuses on the subject in the center of the frame (P.57).• During recording, the  icon blinks and progress will be shown by the indicator at the bottom left.
<p>3</p>  <p>Finish recording.</p> <ul style="list-style-type: none">• Recording will also end automatically when the memory is full.	

Notes on Movies

- Depending on the memory card, recording may end before the memory is full and "CANNOT RECORD MOVIE." is displayed. The incomplete recording is stored as a movie.
- Do not touch the microphone during recording.
- In Movie shooting mode, the following options are fixed:
 - **Flash** (P.28) is  (Flash Cancel) except when recording a time-lapse movie.
 - **Self-timer** (P.30) is **OFF**.
 - **WHITE BALANCE** (P.46) is **Auto**.
 - **Metering** (P.79) is **Matrix**.
- While recording a movie, only digital zoom (up to 2x) can be used (time-lapse movie: up to 4x). Adjust the zoom before recording. When recording starts, the optical zoom position is fixed.
- Only **VA** (Normal) is available for Vibration reduction (P.48).

Recording a Time-Lapse Movie

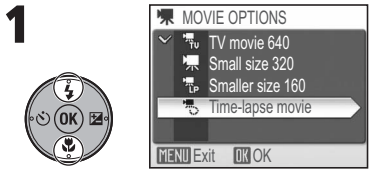
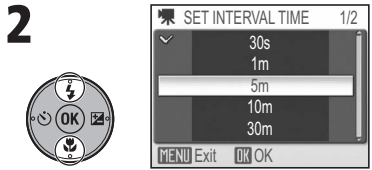
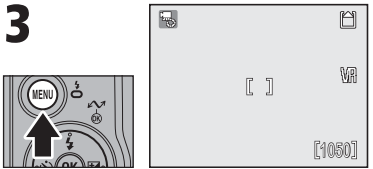
The camera takes pictures at a specified intervals to create a silent movie with a frame rate of 30 frames per second and a frame size of 640 × 480. The maximum recording time is 35 seconds (1,050 frames).

<p>1</p>  <p>Highlight Time-lapse movie in MOVIE OPTIONS menu (P.56) and press OK.</p>	<p>2</p>  <p>Highlight option and press OK. Set option and return to the MOVIE OPTIONS menu.</p>
<p>3</p>  <p>Return to Movie shooting screen.</p>	<p>4</p>  <p>Start recording. Press the shutter-release button to start recording.</p> <ul style="list-style-type: none">• To end recording, press the shutter-release button again, press the power switch, or press  approximately one second.• Recording will end when the memory is full or 1,050 frames have been recorded.







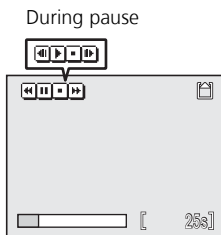

Notes on Time-Lapse Movies

- Recording will end automatically when the battery is exhausted. When recording movies, using the optional EH-62A AC adapter kit is recommended.
- Take a test shot and check the results before recording time-lapse movies.
- When shooting, do not rotate the mode dial.
- The monitor automatically turns off and the power lamp blinks between frames to save power and turns on immediately before the camera takes the next shot.

Movie Playback

Movies are marked with the  icon in Full-screen playback mode (P.49). Press **OK** to play back a movie. Playback controls are displayed at the top of the monitor. Press the multi selector left or right to highlight a control, then press **OK** to perform the selected operation.



During	Icon	Description
Playback		Rewinds movie while OK is pressed.
		Advances movie while OK is pressed.
		Pauses playback.
		Returns to Full-screen playback mode.
Pause		Rewinds paused movie one frame.
		Advances paused movie one frame.
		Resumes playback.
		Returns to Full-screen playback mode.



Playback Volume

The zoom buttons control the volume during playback (except when playing a time-lapse movie). Press **W** to decrease the volume and **T** to increase.



Deleting Movies

Pressing **Del** (P.13) displays the delete confirmation dialog. Highlight **Yes** and press **OK** to delete a movie.

TV, Computer or Printer Connection

When viewing pictures or movies on a TV or computer, using the optional EH-62A AC adapter kit is recommended to prevent the camera from turning off unexpectedly during playback.

Connecting to a TV

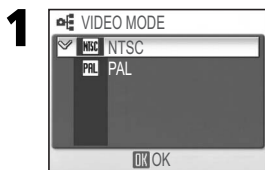

Set **Video mode** option in **INTERFACE** menu of Set-up menu (P.107).
Select **NTSC** or **PAL** to match your TV video standard.

2 Turn camera off and connect supplied EG-CP14 A / V cable (hereafter A / V cable).

Connect the yellow plug to the video-in jack on the TV, and the white plug to the audio-in jack.

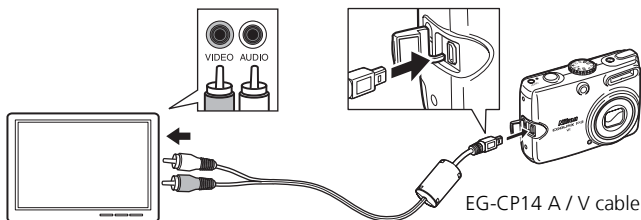

3 Set TV to video input.

- For more information, see the manual for the TV.

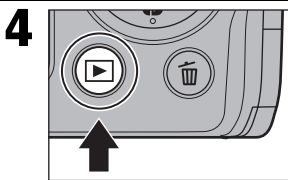

Press  for approximately one second to turn camera on.

The camera monitor will remain off and the TV will show the pictures or movies on the monitor.

Video Output

NTSC is the video standard used in North America and PAL is the one used in many European countries.

Connecting to a Computer

Before transferring pictures or movies to a computer, PictureProject must be installed. For more information on installing and using PictureProject, see the *Quick Start Guide* or the *PictureProject Reference Manual* (on CD).

You can wirelessly transfer pictures and movies to a computer and play them back. For more information, see "Wireless Transfer Mode" (P.109).

1 Start your computer.

- Confirm that PictureProject has been installed on your computer.

2



Set **USB** option in **INTERFACE** menu of Set-up menu (P.107).

Select **PTP** or **Mass storage** depending on your computer's operating system (P.64).

3

Turn camera off and connect supplied UC-E6 USB cable as illustrated.

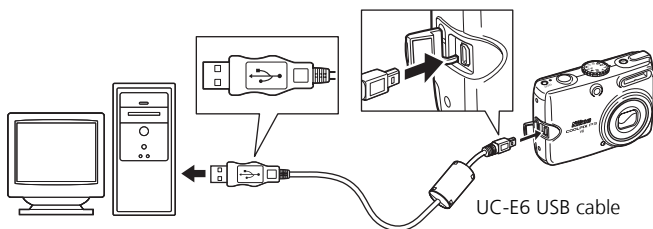

- Operation via a USB hub has not been tested by Nikon.

4

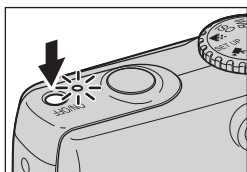

Confirm that mode dial is set to a mode other than  and turn camera on.

5



Data transfer starts.

All pictures and movies marked with the  (Transfer mark) icon (P.95) will be transferred to the computer. Messages on the monitor are shown below.



6

Disconnect camera after transfer is complete (P.66).



Marking Pictures for Transfer

Pictures set for transfer are marked with the  icon in Playback mode. By default, all pictures are automatically marked for transfer.

Two options control transfer marking:

- **Auto transfer** in the Set-up menu (P.107):
Select **On** to mark all new pictures for transfer.
- **Transfer marking** in the Playback menu (P.95):
Select pictures for transferring by marking with the  icon.



PictureProject Transfer Button

To transfer both marked and unmarked pictures to the computer, click **Transfer** in PictureProject instead of pressing  on the camera in step 5.

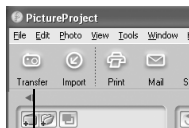



Transfer
button

Selecting a USB Option for Connection to a Computer

Rotate the mode dial to **SET UP** and select **Interface** to set the **USB** option. Consult the following table when selecting a **USB** option for connection to a computer (P.107). The default option is **PTP**.



OS	Camera Transfer  (Transfer )	PictureProject Transfer button
	USB option for transfer	
Windows XP Home Edition Windows XP Professional	Select Mass storage or PTP .	
Windows 2000 Professional Windows Millennium Edition (Me) Windows 98 Second Edition (SE)	Select Mass storage .	
Mac OS X (10.1.5 or later)	Select PTP .	Select Mass storage or PTP .

● Notes on using Windows

If your computer's operating system is Windows 2000 Professional, Windows Millennium Edition (Me), or Windows 98 Second Edition (SE), select **Mass storage** for the **USB** option for connecting the camera to a computer. If **PTP** is selected, disconnect the camera as described below.

Windows 2000 Professional

A dialog will be displayed welcoming you to the Found New Hardware Wizard. Click **Cancel** to close the dialog, and then disconnect the camera.

Windows Millennium Edition (Me)

After displaying a message stating that the hardware information database is being updated, the computer will start the Add New Hardware Wizard. Click **Cancel** to exit the wizard, and then disconnect the camera.

Windows 98 Second Edition (SE)

The Add New Hardware Wizard will be displayed. Click **Cancel** to exit the wizard, and then disconnect the camera.

Notes on Transfer

While transfer is in progress, do not:





- Disconnect the USB cable.
- Turn the camera off.
- Remove the battery or the memory card.
- Disconnect the AC adapter kit.

Failure to observe these precautions may interfere with normal functioning of both the camera and the computer.

Transferring Images Stored in the Internal Memory

Remove the memory card from the camera before connecting the camera to the computer.

Transferring Images Stored on the Memory Card

- To transfer images stored on the memory card, insert the memory card into the camera before connecting to a computer.
- When the SD memory card's write protect switch is in the "lock" position, data transfer using  (Transfer ) is not available. Click **Transfer** in PictureProject to transfer data instead. (If you release the lock, you can use  (Transfer ) to transfer.)

Disconnecting the Camera

When PTP is selected in USB Option:

Turn the camera off and disconnect the USB cable once transfer is complete.

When Mass storage is selected in USB Option:

Turn the camera off after performing the following operations, and disconnect the USB cable.

Windows XP Home Edition/Professional:

Click the “**Safely Remove Hardware**” icon in the notification area and select **Safely remove USB Mass Storage Device** from the menu that appears.



Windows 2000 Professional:

Click the “**Unplug or Eject Hardware**” icon in the notification area and select **Stop USB Mass Storage Device** from the menu that appears.



Windows Millennium Edition (Me):

Click the “**Unplug or Eject Hardware**” icon in the notification area and select **Stop USB Disk** from the menu that appears.



Windows 98 Second Edition (SE):

In My Computer, right click the removable drive corresponding to the camera and select **Eject** from the menu that appears.



Mac OS X:

Drag the untitled camera volume (“NO_NAME”) into the Trash.

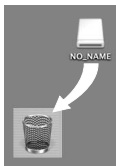

Mac OS X

Connecting to a Printer

When the camera is connected to a PictBridge-compatible printer via the UC-E6 USB cable, selected pictures can be printed directly from the camera.

- You can use Wireless transfer mode (P.109) to print pictures directly from a printer connected to a computer.
- If you use the optional PD-10 wireless printer adapter, you can print pictures directly through a wireless connection. For more information, see the manual for the adapter.

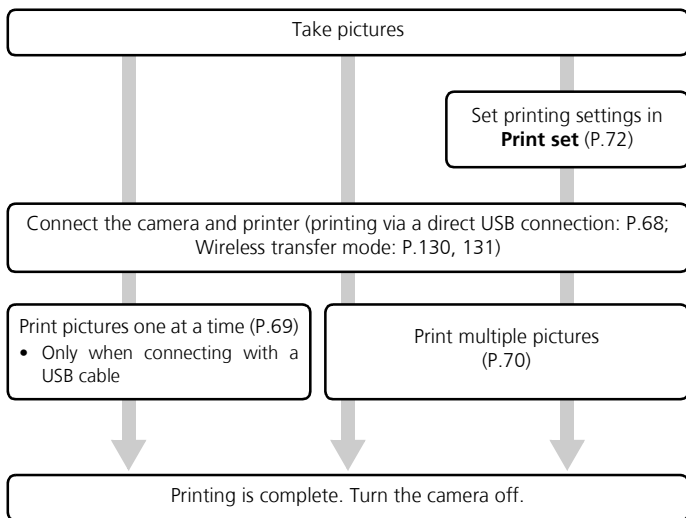

✓ Other Ways to Print Pictures

Pictures can also be printed as follows:

- Insert the memory card containing pictures into a printer equipped with a card slot. If the printer supports Digital Print Order Format (DPOF) (P.154), selected pictures can be printed using **Print set** (P.72). For more information, see the manual for the printer.
- Take the memory card containing the pictures to a digital photo lab.
- To print pictures using **Print set**, check that the photo lab supports DPOF.
- Transfer the pictures to a computer. For more information, see "Connecting to a Computer" (P.62) and the manual for your software or printer.

Connecting the Camera to a Printer



Set **USB** option to **PTP** in **INTERFACE** menu of Set-up menu (P.107).

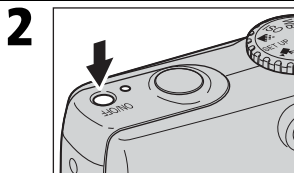

Turn camera off.

3 Turn printer on.

4 Connect supplied UC-E6 USB cable as illustrated.

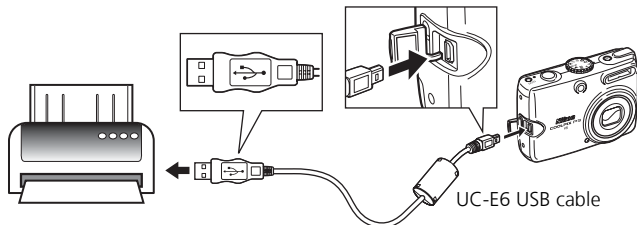

- Operation via a USB hub has not been tested by Nikon.

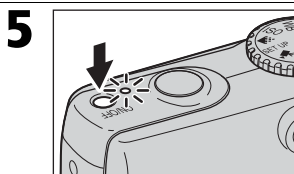

Turn camera on.

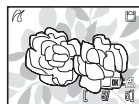

After the PictBridge welcome screen, the picture recorded most recently will be displayed in PictBridge playback mode.



Printing Pictures One at a Time

Connect the camera and printer (P.68), and then follow the steps below:

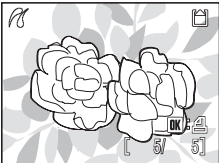

1



Select picture to print in PictBridge playback mode (P.68).

- To select a picture in thumbnail view (P.50), press **W**.

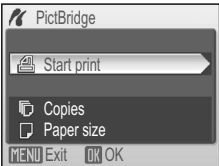
2



Display **PictBridge** menu.

3



Confirm settings and print pictures.
Press the multi selector up or down to highlight an option and press **OK** to select:

Start print	Printing begins. The camera returns to the PictBridge playback screen when printing is complete.
Copies	Press the multi selector up or down to set the number of copies (up to 9). Press OK to return to the PictBridge menu.
Paper size	Press the multi selector up or down to set the page size. Press OK to return to the PictBridge menu.

PictBridge

PictBridge is an industry standard for direct printing from digital cameras to printers that ensures compatibility regardless of the make of devices.

Note on Paper Size

The camera supports the following paper sizes:

Default, **3.5" x 5"** (89 mm x 127 mm), **5" x 7"** (127 mm x 178 mm), **Postcard**, **100mm x 150mm** (3.9 in. x 5.9 in.), **4" x 6"** (102 mm x 152 mm), **8" x 10"** (203 mm x 254 mm), **Letter** (8.5 in. x 11 in., 216 mm x 279 mm), **A3** (11.7 in. x 16.5 in., 297 mm x 420 mm), **A4** (8.3 in. x 11.7 in., 210 mm x 297 mm). Only sizes supported by the current printer will be displayed. Select **Default** to print using the paper setting in the printer.

Printing Multiple Pictures

Connect the camera and printer (P.68), and then follow the steps below:

1

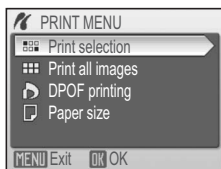

Display **PRINT MENU**.

Press **MENU** in PictBridge playback mode (P.68).

2



Select pictures to print and confirm settings.

Press the multi selector up or down to highlight an option and press **OK** to select:

Print selection	Select pictures and set the number of copies. Go to step 3.
Print all images	Prints one copy of all the pictures in the internal memory or on the memory card. The camera returns to the PRINT MENU when printing is complete.
DPOF printing	Print pictures according to the print order specified in Print set (P.72). To start printing immediately, highlight Start print and press OK . To view selected pictures before printing, highlight Confirm and press OK . Go to step 4.
Paper size	Select the size of paper for printing (P.69).

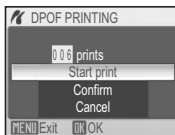

3

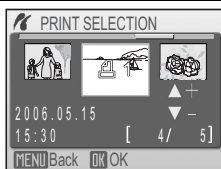

Select pictures to print and set number of copies (up to 9).

Press the multi selector left or right to select a picture, and up (+) or down (-) to set the number of copies (P.73).

- The number of copies and the  icon are marked on the selected picture.
- To deselect a picture, press the multi selector down (-) when the number of copies is 1.

4



Selected pictures are displayed.

- To return to the **PRINT SELECTION** screen, press **MENU**.

5

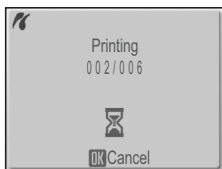



Start printing.

- The camera returns to the **PRINT MENU** when printing is complete.
- To cancel printing, press **OK**.

Creating a DPOF Print Order: Print Set

You can create a digital "print order" specifying the pictures to print, the number of copies, and the information to be included with each print. The pictures can be printed using **Print set** settings with a DPOF-compatible device or at a digital photo lab which supports DPOF (P.154).

 Print selected	Select pictures to create a print order.
 Choose date	Set a print order to print all pictures taken on the same date.
 Delete print set	Cancel all print settings.

TV, Computer or Printer Connection

Creating a Print Order

1



Highlight **Print set** in Playback menu (P.89) and press **OK**.

2

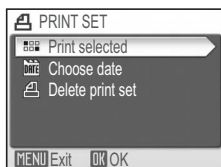

Highlight **Print selected** and press **OK**.

3

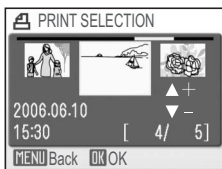

Highlight picture to be printed.

4

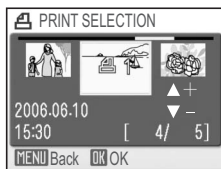

Select current picture.
Press the multi-selector up to display 1 (number of copies) and the  icon on the selected picture.



Canceling the Print Order

To cancel all print settings, highlight **Delete print set** and press **OK**.

5

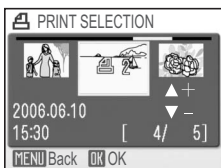

Set number of copies and press **OK**. Press the multi selector up (+) or down (-) to set the number of copies (up to 9).

- To deselect a picture, press the multi selector down (-) when the number of copies is 1.
- Repeat steps 3 to 5 to select additional pictures.

6

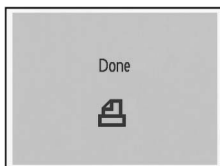
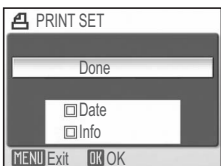

Set **Date** and **Info** options.

- To print the recording date on all pictures in the print order, highlight **Date** and press **OK**. A will be displayed in the check box.
- To print the shutter speed and aperture on all pictures in the print order, highlight **Info** and press **OK**. A will be displayed in the check box.
- To cancel the selected option, highlight it and press **OK**.
- To complete the print order, highlight **Done** and press **OK**.

Setting Print Order by Day

You can set a print order to print all pictures taken on the same date.

1

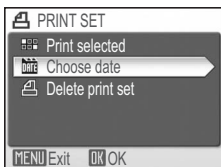

In **PRINT SET** menu (P.72), highlight **Choose date** and press **OK**.

2

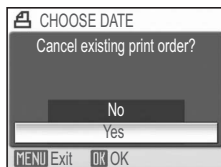

Highlight **Yes** and press **OK**.

- To cancel, highlight **No** and press **OK**.

3



Highlight date.

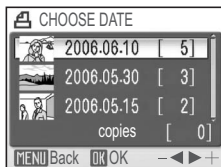

4



Set number of copies and press **OK**.

Press the multi selector right (+) to display 1 (the number of copies) on a thumbnail image of the selected date.

- Press the multi selector left (-) and right (+) to set the number of copies (up to 9).
- To deselect a picture, press the multi selector left (-) when the number of copies is 1.
- Repeat steps 3 and 4 to select other dates.

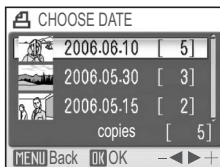

5

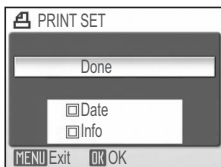

Set **Date** and **Info** options.

- To print the recording date on all pictures in the print order, highlight **Date** and press **OK**. A **✓** will be displayed in the check box.
- To print the shutter speed and aperture on all pictures in the print order, highlight **Info** and press **OK**. A **✓** will be displayed in the check box.
- To cancel the selected option, highlight it and press **OK**.
- To complete the print order, highlight **Done** and press **OK**.

Print Set

If you display the **PRINT SET** menu after creating a print order, the **Date** and **Info** options will be reset.

✓ **Date**

If **Date** is selected, the recording date will appear on pictures printed using DPOF. The date to be printed will remain unchanged even if **Date** in the Set-up menu is changed after shooting pictures. If a picture is taken without setting the camera clock, the date will not be printed even if **Date** is selected in the **PRINT SET** menu.

✓ **Differences Between Print Set and Date Imprint**

The differences between **Print set** in the Playback menu and **Date imprint** (P.102) in the Set-up menu are as follows:

- Setting **Date** in the **PRINT SET** menu:
 - The recording date can be printed only with a printer that supports date-print configuration for DPOF.
 - You can set the option after taking pictures.
 - The date is not imprinted on the image itself, but recorded in the DPOF setting files. When printing, the date will be printed on the image. The position of the date depends on the printer.
- Setting **Date imprint** in the Set-up menu:
 - The date is imprinted in the images and can be printed without making other settings.
 - The option must be set before taking pictures.
 - The position of the date is fixed at the bottom right hand corner of the picture.
 - Once the date is imprinted, it cannot be deleted from the image.
- When the **Date** and **Info** options in **Print Set** and **Date imprint** are set, only the date from the **Date imprint** option will be printed even when using a printer that supports DPOF.

✓ **If an Error Occurs**

If an error message is displayed, check the printer and resolve the problem as directed in the printer manual. Highlight **Resume** and press **ⓧ** to resume printing. Select **Cancel** to exit without printing the remaining images.

Resume may not be available depending on the type of error. In this case, select **Cancel**.

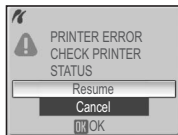

✓ **Notes on DPOF Printing**

- **DPOF printing** is available only when a print order is created for the pictures stored in the internal memory or on the memory card using **Print set**.
- When printing directly with a printer that supports PictBridge, shooting information cannot be printed even if **Info** is selected in **PRINT SET** menu.



Printing the Recording Date and Time on Pictures

The recording date and time can be printed by one of the following methods:

- Before taking pictures, set the **Date imprint** option in the Set-up menu (P.75, 102).
- Set the **Date** option in the **PRINT SET** menu of the Playback menu (P.72 - 74).
- Transfer the pictures to a computer and print them using PictureProject print settings. For more information, see the *PictureProject Reference Manual* (on CD).

Advanced Camera Settings

Using the Menus

Shooting, playback, movie, and camera set-up menus are available.

Displaying the Menus

To display the Shooting menu (P.78):



Rotate mode dial to
P or **A**.



Press **MENU**.

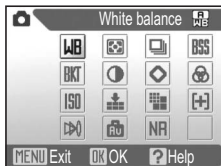

To display the Playback menu (P.89):



Press



Press **MENU**.



To display the Movie menu (P.56):

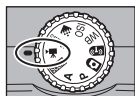

Rotate mode dial to



Press **MENU**.



- Press **MENU** to return to Shooting or Playback mode from the Shooting, Playback and Movie menus.

To display the Set-up menu (P.98):

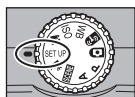

Rotate mode dial to
SET UP.





- Rotate the mode dial or press to exit the Set-up menu.

Navigating the Menus

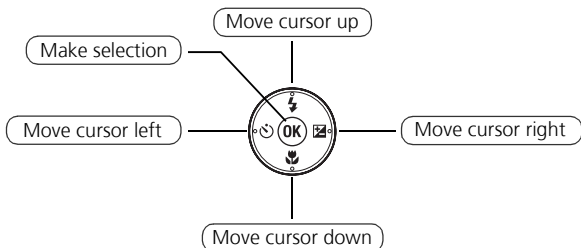
When navigating the menus, use the multi selector.

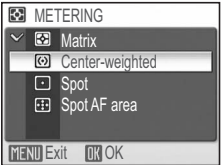

<p>1</p>  <p>Highlight menu item.</p>	<p>2</p>  <p>Display options.</p>
<p>3</p>  <p>Highlight option.</p>	<p>4</p>  <p>Select highlighted option.</p>

The Shooting Menu

The Shooting menu includes the items in the following table. See “Using the Menu” (P.76) for more information on displaying and using the Shooting menu.



WB	White balance	Match white balance to your light source.	P.46
Metering		Select how the camera sets exposure.	P.79
Continuous		Take pictures one at a time or in a sequence.	P.80
BSS	BSS	Use the Best Shot Selector (BSS) to select the sharpest picture.	P.82
BKT	Auto bracketing	Take a sequence of pictures with gradually changing exposure or white balance.	P.83
Image adjustment		Adjust picture contrast.	P.84
Image sharpening		Control how much outlines in your pictures are sharpened in the camera.	P.84
Saturation control		Adjust vividness of the color of a picture.	P.85
ISO	Sensitivity	Select ISO Sensitivity.	P.45
Image quality		Select image quality.	P.43
Image size		Select an image size for displaying or printing.	P.43
AF area mode		Select where the camera focuses.	P.86
Auto-focus mode		Select how the camera focuses.	P.87
Fixed aperture		Maintains aperture as close as possible to a set <i>f</i> -number when the camera is zoomed in and out.	P.88
NR	Noise reduction	Reduce noise that may appear when long exposures are used.	P.88

Metering



The camera's built-in light metering system calculates the brightness of the subject to determine the best exposure to use.

Matrix (default setting)	Analyzes the distribution of brightness over a wide area of the frame, producing optimal results for most situations.
Center-weighted	Meters the entire frame but assigns the greatest weight to the center area. Suitable for portraits. Use with AF lock (P.87) to meter off-center subjects.
Spot	Measures light in an area shown by a square in the center of the monitor. The subject in the metering target area will be correctly exposed even when the background is much brighter or darker. Use with AF lock (P.87) to meter off-center subjects.
Spot AF area	Links spot metering to the active focus area when AF area mode is set to Auto or Manual (P.86).



Note on Metering

When digital zoom is used, the camera automatically switches to a setting similar to **Center-weighted**. However, the metering target does not appear.



Metering

When **Center-weighted** or **Spot** is selected, the metering target is displayed in the center of the monitor.

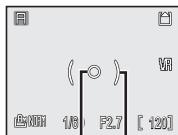











Spot metering target

Center-weighted
metering target

Continuous





Select one of the following six options.

 Single (default setting)	Takes one picture each time the shutter-release button is fully pressed.
 Continuous	While the shutter-release button is pressed, pictures can be taken continuously. The first five shots are taken at up to 1.8 frames per second (fps).
 Multi-shot 16	Each time the shutter-release button is fully pressed, the camera takes 16 shots at approximately 1.7 fps. The camera arranges pictures in four rows to form a single picture measuring  3264x2448 pixels. 
 Ultra HS	While the shutter-release button is pressed, the camera takes up to 100 pictures of  640x480 pixels at up to 30 fps. With each sequence, the camera creates a new folder (XXXN_XXX) in which all photos in the sequence are stored. The number of exposures remaining is shown in the shooting display.
 5 shot buffer	While the shutter-release button is pressed, pictures can be taken at a rate of up to approximately 1.8 fps. When the shutter-release button is released, continuous shooting will stop. Only the last five images taken during each continuous shooting burst will be recorded in the internal memory or on the memory card.
 Intvl timer shooting	Takes pictures automatically at a specified interval. Set the interval (30 seconds, 1, 5, 10, 30, 60 minutes) first and then press the shutter-release button.  <ul style="list-style-type: none"> • The camera will take pictures at the specified interval until the shutter-release button is pressed again, the internal memory or memory card is full, or 1,800 frames have been recorded. • Press  to finish shooting and return to Playback mode. • If you press the power switch, shooting finishes and the camera turns off.

✓ Restrictions on Continuous Shooting



- Settings other than **Single** cannot be used in combination with **BSS** (P.82), **Auto bracketing** or **WB bracketing** (P.83). The previous setting is used and the earlier setting is canceled.
- **Noise reduction** (P.88) has no effect even if set to **On**.
- With **Continuous**, **Multi-shot 16**, **Ultra HS**, and **5 shot buffer**, settings for focus, exposure, and white balance are determined by the first shot in each series. The flash is automatically set to  (Flash Cancel).
- Digital zoom (P.25) cannot be used at settings of **Multi-shot 16** or **Ultra HS**.
- When using the self-timer, **Single** is automatically set. The settings will return to the previous setting after an image has been taken using the self-timer.

✓ Ultra HS

- During shooting, progress is shown on the monitor, from **S** to **E**. To interrupt shooting before 100 pictures have been recorded, lift your finger from the shutter-release button.
- During shooting, pressing  while the  icon appears displays the delete confirmation dialog. From this screen, you can delete all the pictures in the same sequence.
- During shooting, the shutter sound is off.



✓ 5 Shot Buffer

If **Image size** is set to  **3264x2448** or  **3264x2176** and **Image quality** is set to **FINE**, only the last three images taken in a series will be recorded.

✓ Note on Interval Timer Shooting

To prevent shooting from ending unexpectedly, use the optional EH-62A AC adapter kit.

✓ Interval Timer Shooting

- To save power, the monitor turns off and the power on lamp starts blinking between shots. The display turns on automatically immediately before the camera takes the next shot.
- Do not rotate the mode dial during the interval between shots.

BSS



When Best Shot Selector (BSS) is on, the camera takes up to 10 pictures while the shutter-release button is pressed. The sharpest picture in the series is saved and the others are discarded. BSS is recommended when:

- The camera is zoomed in.
- The camera is in Macro close-up mode.
- Shooting with the flash off when lighting is poor.

Off (default setting)	Turns BSS off.
On	Turns BSS on. The flash is automatically set to , and settings for the focus, exposure and white balance are determined by the first shot in the series.





Note on BSS

BSS may not produce good results with a moving subject or if the composition is changed while the shutter-release button is pressed.

Auto Bracketing

BKT

Use this function when unusual lighting conditions make it difficult to determine the correct exposure or proper white balance settings. Auto bracketing automatically adjusts these settings over a series of pictures, “bracketing” a selected Exposure compensation or White balance setting.

 Off (default setting)	Turns bracketing off.
 Auto bracketing	Takes three shots each time the shutter-release button is fully pressed, one shot with the current exposure, and two shots varying the exposure by values of +0.5 and -0.5.
 WB bracketing (white balance bracketing)	Takes three shots each time the shutter-release button is fully pressed, bracketing the current white balance setting (P.46) to produce one picture with normal white balance, one picture with a bluish cast, and one picture with a red-dish cast. Recording time roughly triples.

Notes on Auto Bracketing

- When **AUTO BRACKETING** is set to **Auto bracketing**, the flash is automatically set to .
- When **AUTO BRACKETING** is set to **Auto bracketing** or **WB bracketing**, **Noise reduction** (P.88) has no effect even if set to **On**.

Exposure Compensation

When Exposure compensation (P.32) and **Auto bracketing** are set simultaneously, shots will be bracketed on both sides of the chosen compensation value.

WB Bracketing

WB bracketing cannot be selected if **White balance** (P.46) is set to **White bal. preset**.

Image Adjustment

This setting adjusts contrast for optimal results before storing pictures in the internal memory or on the memory card.



 Auto (default setting)	Automatically adjusts contrast according to shooting conditions.
<input type="checkbox"/> Normal	Performs the same standard contrast adjustment on all pictures. Suitable for a wide variety of scenes, from dark to bright.
 More contrast	Processes the picture to emphasize the difference between light and dark areas, enhancing contrast. Useful when shooting under overcast skies or for low-contrast subjects.
 Less contrast	Processes the picture to decrease the difference between light and dark areas, reducing contrast. Recommended when lighting is very bright, creating strong shadows on the subject.

Image Sharpening

This option automatically processes pictures to add sharpness and greater definition to images.





 Auto (default setting)	Sharpens edges for optimal results; amount varies from shot to shot.
 High	Increases sharpness, making edges more distinct.
 Normal	Performs a standard level sharpening on all images.
<input type="checkbox"/> Low	Reduces sharpening below normal level.
 Off	Turns sharpening off. Select if retouching pictures on a computer.

Image Sharpening Effects

You cannot check the Image sharpening effects on the monitor while shooting. To see the results, play back the picture.

Saturation Control



Saturation control increases or decreases the vividness of colors.

+2 Maximum	Gives vivid color effects. Select when printing pictures "as is," without further modification.
+1 Enhanced	
±0 Normal (default setting)	Best choice for most situations.
-1 Moderate	Select if retouching pictures on a computer.
-2 Minimum	

AF Area Mode

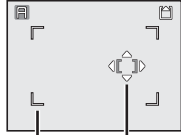
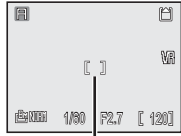

Use this option to determine where the camera focuses.

<p> Auto (default setting)</p>	<p>Automatically selects a focus point from 11 focus areas containing the subject closest to the camera. The selected focus area is displayed when the shutter-release button is pressed halfway. This setting is useful when taking snapshots or you do not have time to check the focus.</p>	 <p>Focus area</p>
<p> Manual</p>	<p>You can select a focus point from 99 focus areas using the multi selector. This option can be used instead of AF lock (P.87) to focus on a relatively motionless subject that is not at the center of the frame. When Manual is selected, the focus area and selectable area are displayed. Use the multi selector to move the focus area over the desired subject.</p>	 <p>Focus area Selectable area</p>
<p> Center</p>	<p>The center focus area is used. This option can be used in combination with AF lock (P.87) to keep off-center subjects in focus.</p>	 <p>Focus area</p>



Focus Area Display

- When the subject is in focus, the focus area will be outlined in green.
- When the subject is out of focus, the focus area will blink red.
- When **AF area mode** is set to **Auto**, the focus area will be displayed when the shutter-release button is pressed halfway.

Auto-focus Mode



Use this option to determine how the camera focuses when shooting still pictures.

 Single AF (default setting)	Focuses only when the shutter-release button is pressed halfway.
 Full-time AF	Adjusts the focus continuously even when the shutter-release button is not pressed halfway. Use this setting for shooting moving subjects.

AF Lock

Focus and exposure are locked when the shutter-release button is pressed halfway, and remain locked while the shutter-release button is held in this position (AF lock). AF lock can be used to take pictures of off-center subjects or in situations in which the camera is unable to focus using Autofocus (P.147). Procedures for AF lock are described below. In this example, **AF area mode** (P.86) is set to **Center**.

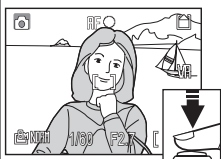

1 Focus.

Position the subject in the center of the frame and press the shutter-release button halfway.

2 Check focus indicator.

When the subject is in focus, the focus indicator on the monitor lights up. The focus area is outlined in green on the monitor.

- Focus and exposure will remain locked while the shutter-release button is pressed halfway.

3 Recompose picture.

- Keeping the shutter-release button pressed halfway, re-compose your picture. The distance between the camera and your subject should not change while the focus is locked. If your subject moves, lift your finger from the shutter-release button, focus again at the new distance and then re-compose your shot.

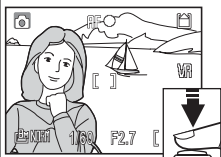

4 Press shutter-release button the rest of the way down to take picture.





For more information, see “Getting Good Results with Autofocus” (P.147).

Fixed Aperture





This option keeps the aperture from shifting when zooming. This function is available only when the dial mode is set to **A**.

 Off (default setting)	Aperture changes with the zoom position.
 On	Aperture is kept as close as possible to the f/-number selected by you or the camera. To prevent the selected f/-number from exceeding the exposure range at the new zoom position, select an aperture from f/5 to f/7.3.

Noise Reduction



At slow shutter speeds, “noise” in the form of randomly-spaced, brightly-colored pixels may appear in pictures, particularly in shadowy areas. When you take pictures under low levels of light, this option reduces noise.

 Off (default setting)	Turns Noise reduction off.
 On	Noise reduction takes effect at slow shutter speeds which “cause” noise. When Noise reduction is on, it takes longer to store pictures in the internal memory or on the memory card.













Note on Noise Reduction

When using **Continuous** mode (P.80) or when **AUTO BRACKETING** (P.83) is set to **Auto bracketing** or **WB bracketing**, **Noise reduction** (P.88) has no effect even if set to **On**.

The Playback Menu

The Playback menu includes the items in the following table. See “Using the Menus” (P.76) for more information on displaying and using the Playback menu.



 List by date	Sort pictures by the recording date. Perform five options (D-Lighting , Print set , Delete , Transfer marking , or Small pic.) on selected pictures.	P.92
 D-Lighting	Adjust the tone (brightness) of a picture and save a copy.	P.92
 Print set	Select pictures to print using a DPOF-compatible device; specify the number of copies and whether to include shooting information and the date.	P.72
 Slide show	View pictures in an automatic slide show.	P.93
 Delete	Delete all or selected pictures.	P.94
 Protect	Protect pictures from accidental deletion.	P.94
 Transfer marking	Select pictures to transfer to a computer by marking them with the  icon.	P.95
 Small pic.	Create a small copy of the current picture.	P.96
 Copy	Copy pictures between the internal memory and the memory card.	P.97

Navigating the Picture Selection Screen

When selecting a picture in **Print set** (P.72), **Delete** (P.94), **Protect** (P.94), **Transfer marking** (P.95) or **Copy** (P.97), a picture selection screen, such as the screen on the right, is displayed.



1



Highlight picture.

The selected picture is displayed in the center.

2



Set function on/off (or number of copies).

An icon corresponding to the function appears on the picture when the function is set on.

- Repeat steps 1 and 2 to select additional pictures.
- To cancel an option, highlight the picture and press the multi selector down to remove the icon.

3



Exit picture selection screen.

- For **Print set**, the **PRINT SET** menu appears.
- For **Protect** and **Transfer marking**, no further operations are required.
- For **Delete** and **Copy**, a confirmation dialog is displayed. Select **Yes** and press **OK** to delete or copy.

Navigating the Choose Date Screen

When **Choose date** is selected in **Print set** (P.72), **Delete** (P.94) or **Transfer marking** (P.95), a **CHOOSE DATE** screen, such as the screen on the right, is displayed. The above menu options affect all pictures recorded on the same date.

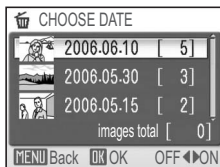

1



Highlight date.

The screen shown above is displayed when **Choose date** is selected in **Delete**.

- A thumbnail image of the first shot, the recording date, and the number of images for that date are displayed.

2

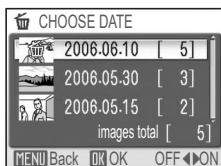

Set function on/off (or the number of copies).

- An icon corresponding to the function appears on the picture when the function is set on.
- Repeat steps 1 and 2 to select other dates.
- To cancel an option, highlight the date and press the multi selector left to remove the icon.

3



Exit **CHOOSE DATE** screen.

- For **Print set**, the **PRINT SET** menu appears.
- For **Transfer marking**, all pictures for the selected date are set for transfer.
- For **Delete**, a delete confirmation dialog is displayed. Select **Yes** and press **OK** to delete all pictures for the selected recording date.

Pictures Grouped in Others

In the **Choose date** (P.91) or **List by date** (P.92) option, pictures are grouped up to 30 days from the most latest recording date. Older pictures are grouped in a folder called **Others** as pictures taken on the same recording date and listed as the last item.

Choose Date and List by Date

Pictures with no date set (P.22, 100) are not grouped.

List by Date



Pictures in the internal memory or on the memory card are sorted by the recording date.

The following five operations can be performed on all pictures on the same date:

D-Lighting, **Print set**, **Delete**, **Transfer marking**, and **Small pic**.

1

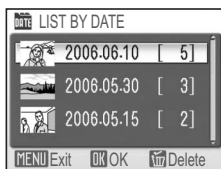

Highlight date.

- A thumbnail image of the first shot, the recording date, and the number of images for that date are displayed.
- Pressing deletes all of the pictures on the same recording date.

2

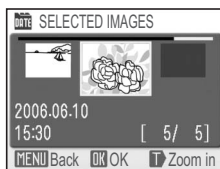

Display **SELECTED IMAGES** screen.

- To switch to Full-screen playback mode, press **Q** (**T**). Press **W** (**W**) to return to the **SELECTED IMAGES** screen.
- Press the multi selector left or right to highlight a picture. Press **OK** to select an option: **D-Lighting** (P.92), **Print set** (P.72), **Delete** (P.94), **Transfer marking** (P.95), or **Small pic** (P.96).

D-Lighting



You can adjust the tone (brightness) of a picture and save it as a separate file. Dark or backlit subjects can have their brightness and contrast enhanced.

The original picture is displayed on the top left side of the monitor and the adjusted picture is displayed on the top right side.

- Pictures created with D-Lighting are marked with the icon in Playback mode.

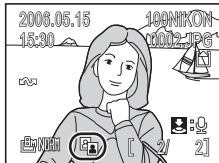
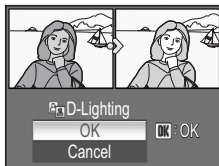



Slide Show



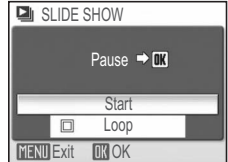

Pictures in the internal memory or on the memory card can be played back in an automated "slide show" with a three-second interval between images.

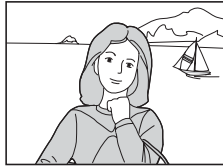
- Pictures are played back in the recorded order (smallest to largest file number).
- The maximum playback time for a slide show is 30 minutes.

<h1>1</h1>  <p>Highlight Start.</p> <ul style="list-style-type: none"> • To repeat the slide show automatically, highlight Loop and press OK before selecting Start. A ✓ is displayed in the check box. 		<h1>2</h1>   <p>Start slide show.</p>
--------------------------------------------------------------------------------------------------------------------------------------------------------------------------------------------------------------------------------------------------------------------------------------------------------------------------------------------	-----------------------------------------------------------------------------------	---------------------------------------------------------------------------------------------------------------------------------------------------------------------------------------------------------

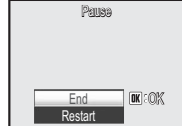
The following operations can be performed during the slide show:

Pause		<p>Pauses the slide show and displays the menu. Highlight Restart and press OK to resume the show. Highlight End and press OK to end the slide show.</p>	
Skip to next frame		<p>Skips to the next picture. Press and hold to fast forward.</p>	
Return to previous frame		<p>Returns to the previous picture. Press and hold to rewind.</p>	
End slide show	MENU	<p>Ends the slide show and returns to Full-screen playback mode.</p>	

Notes on the Slide Show

- If no operations are performed for 30 minutes after the slide show starts, the monitor will turn off due to the **Auto off** function. The camera will turn off automatically if no operations are performed for another three minutes. (The camera will also turn off when **Loop** is set.)
- Movies are displayed as still images showing the first frame.

Delete



You can delete selected pictures or all pictures stored in the internal memory or on the memory card.

- When a memory card is in the camera, only the pictures stored on it are deleted.
- When there is no memory card in the camera, pictures stored in the internal memory are deleted.

Erase selected images	Deletes pictures selected in the ERASE SELECTED IMAGES screen (P.90).
Choose date	Deletes pictures with the same recording date selected in the CHOOSE DATE screen (P.91).
Erase all images	Deletes all pictures stored in the internal memory or on the memory card. <ul style="list-style-type: none"> • In the delete confirmation dialog, highlight Yes and press OK to delete all pictures.



Note on Voice Memo

To delete only the voice memo recorded with the picture, press in Full-screen playback mode, Thumbnail playback mode, or Playback zoom mode (P.55).



Notes on Deletion

- Once deleted, pictures cannot be recovered. Transfer important images to a computer before deletion.
- Pictures marked with the icon are protected and cannot be deleted.

Protect



The pictures can be protected from accidental deletion. Protected pictures are marked with the icon in Playback mode.

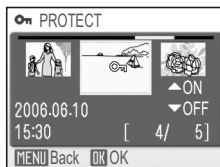









Note on Protecting Pictures

Protected pictures cannot be deleted. However, all pictures, including protected files, will be deleted when the internal memory or the memory card is formatted (P.106).



Transfer Marking



You can select pictures for transferring to a computer by marking with the  icon.

 All on	Adds the  icon to all pictures in the internal memory or on the memory card.
 All off	Removes the  icon from all pictures in the internal memory or on the memory card.
 Choose date	Adds or removes the  icon on all pictures from the same recording date (P.91).
 Select image(s)	Adds or removes the  icon on pictures selected in the TRANSFER MARKING screen (P.90).

Notes on Transfer Marking

- No more than 999 pictures can be marked with the  icon using Transfer marking. To transfer more than 999 pictures, use PictureProject. For more information, see the *PictureProject Reference Manual* (on CD).
- If a memory card in which pictures selected by another model of camera to transfer is inserted, this camera cannot recognize the transfer settings. Use this camera to select the pictures to transfer again.
- In the default setting, the **Auto transfer** option is set to **On** (P.107). All pictures are set to transfer and marked with the  icon when displayed.

The Transfer Marking Icon

The selected pictures are marked with the  icon in Playback mode.

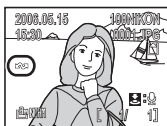

Full-screen playback



Thumbnail playback
(4 thumbnail display only)

Small Pic.



You can create a small copy of a picture displayed in Full-screen playback mode.

The following resize options are available.

640 × 480	Suitable for displaying on a TV.
320 × 240	Suitable for displaying on web pages.
160 × 120	Suitable as an attachment to e-mail.



Notes on Small Picture

- Copies are stored as JPEG files with **Image quality** set to **BASIC** (compression ratio 1:16).
- Small pictures cannot be zoomed in on.

Copy



You can copy selected pictures (P.90) or all pictures from the internal memory to the memory card, or vice versa.

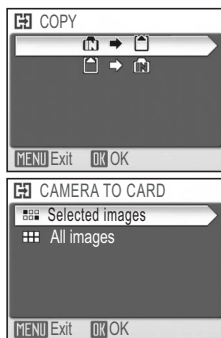

	Copies pictures stored in the internal memory to the memory card.
	Copies pictures stored on the memory card to the internal memory.

Notes on Copying Pictures

- If there is not enough space in the destination memory, copying is canceled and an error message is displayed.
- The available file formats for copying are JPEG, MOV and WAV. You cannot copy pictures in other file formats.
- You cannot copy the pictures taken with another make of camera or retouched on a computer.

File Name

- When copying using **Selected images**, the newly copied pictures are numbered consecutively from the largest number existing between the two memory sources.
Ex: When the last number in the source memory is 32 (DSCN0032.JPG) and the last number in the destination memory is 18 (DSCN0018.JPG), the copied pictures are assigned numbers starting from 33 (DSCN0033).
- When copying using **All images**, all folders in the internal memory or on the memory card are copied. The newly copied folders are assigned new folder numbers (one is added to the highest folder number in the destination memory). If a new folder cannot be created, copying is canceled and an error message is displayed.















Print Set, Transfer Marking, and Protect

If pictures are set with **Print set** (P.72) or **Transfer marking** (P.95), the settings are not copied. **Protect** setting (P.94) can be copied and the copied picture is protected.

The Set-up Menu

The Set-up menu includes the items in the following table. See “Using the Menus” (P.76) for more information on displaying and using the Set-up menu.



 Menu	Select the type of menu display for the Shooting, Movie, Playback and Set-up menus.	P.99
 Welcome screen	Select the welcome screen displayed when the camera is turned on.	P.99
 Date	Set the camera clock and time zone.	P.100
 Monitor settings	Display the current settings and adjust the brightness of the monitor.	P.101
 Date imprint	Imprint the recording date/time on pictures.	P.102
 Shot confirmation	Set the Shot confirmation LED to light after each shot.	P.104
 AF assist	Set the AF-assist illuminator to light when focusing.	P.104
 Sound settings	Set the button sound, the volume of shutter and start-up sounds.	P.105
 Auto off	Set the time before the camera enters Standby mode automatically to save power.	P.105
 Format memory/card	Format the internal memory or memory card.	P.106
 Language	Select a language for the camera menus and messages.	P.106
 Interface	Set USB and Video mode options.	P.107
 Auto transfer	Set all pictures to transfer before shooting.	P.107
 Reset all	Restore camera settings to default.	P.108
 Firmware version	Displays the firmware version of the camera.	P.108

Menus



The Shooting, Movie, Playback and Set-up menus can be displayed using text or icons.

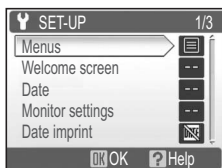

Text



Icons

Welcome Screen



You can select the welcome screen to be displayed when the camera is turned on.

Disable welcome	A welcome screen is not displayed when the camera is turned on.
Nikon	Displays a welcome screen when the camera is turned on.
Animation (default setting)	Displays a short animation when the camera is turned on.
Select an image	<p>Select a picture in the internal memory or on the memory card for the welcome screen.</p> <ol style="list-style-type: none"> 1 Highlight Select an image and press OK to display SELECT IMAGE screen. 2 Press multi selector left or right to highlight picture. 3 Press OK to select picture for welcome screen.



When "Select an image" is Selected

If you have already selected a welcome screen picture, you can select a new one by following the confirmation dialog.



Date



Use this option to set the time and date.

When traveling, you can use the **Time zone** option to automatically display the date and time at your destination (the camera calculates the time zone differences).

Date	Set the camera clock to the current date and time. For more information, see “Basic Setup” (P.22).
Time zone	Select a time zone for ➤ (new city time zone) to display the date and time in that selected region (P.148). <div data-bbox="751 375 951 525" style="float: right; border: 1px solid black; padding: 5px; margin-top: 10px;"> </div> <p style="text-align: right; margin-top: 10px;">Dot marks selected option</p>

1

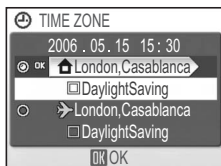

Highlight home time zone or new city time zone.

- To set the clock for the home time zone, highlight **🏠** and press **OK**.
- To set the clock for the new city time zone, highlight **➤** and press **OK**.
- To set daylight saving time on, highlight **DaylightSaving** and press **OK**. A **✓** is displayed in the check box.

2



Display map of world time zones.

3



Select time zone and press **OK**.
The time zone is set.

Note on the Clock Battery

The clock battery charges when the main battery is installed or the optional EH-62A AC adapter kit is connected. When fully charged after approximately 10 hours of charging, the clock battery can provide a few days of back-up power for the clock.

Monitor Settings



You can set the monitor indicators on/off, and adjust the brightness of the monitor.

Photo Info

Show info (default setting)	Displays the current settings or operation guide on the monitor when taking or viewing pictures.	
Auto info	Displays the current settings or operation guide on the monitor for five seconds.	
Hide info	The operation guide or current settings are not displayed on the monitor.	
Framing grid	Displays the operation guide or current settings on the monitor. In P (Programmed auto) or A (Aperture-priority auto) mode, a framing grid is displayed; the current settings or operation guide is displayed on the monitor for five seconds.	

Brightness

The monitor has five levels of brightness adjustment.







Date Imprint





Date information will be imprinted on the bottom right corner of pictures when shooting. The imprinted date will be printed even if a printer does not support DPOF.

You cannot use this option to imprint a date stamp on pictures after recording.

 Off (default setting)	Time and date will not be imprinted on pictures.
 Date	Imprints date on pictures.
 Date and time	Imprints date and time on pictures.
 Date counter	Imprints number of days between date of shooting and selected date on pictures.

Notes on Date Imprint

- An imprinted date cannot be deleted.
- **Date imprint** is not available in  **PANORAMA ASSIST** or **Ultra HS** mode or when shooting movies.
- **Date imprint** cannot be selected if the camera clock has not been set (P.22,100).
- An imprinted date may be difficult to read when **Image size** (P.43) is set to  **640×480**. We recommend selecting  **1024×768** or larger image sizes when imprinting the date.
- The date is imprinted in the order selected in **Date** (P.22,100).

Date Counter

Use this option to imprint the number of days remaining until a specified date or the number of elapsed days since a specified date. Use this option to track the growth of a child or count down the days until a birthday or wedding.

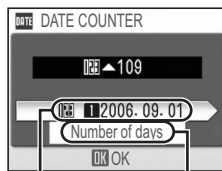

Press **OK** to display **STORED DATES** screen.

Press **OK** to display **DISPLAY OPTIONS** screen.

<p>STORED DATES</p>	<p>Store up to three dates.</p> <ol style="list-style-type: none"> 1 Highlight option and press multi selector right to display STORED DATES screen. 2 Set date (P.22) and press OK. To select a date, highlight an option and press OK. 	
<p>DISPLAY OPTIONS</p>	<p>Highlight a display option and press OK.</p>	

The date counter will be imprinted on the pictures as shown below.

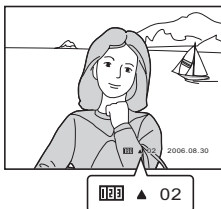

Two days remaining until the specified date

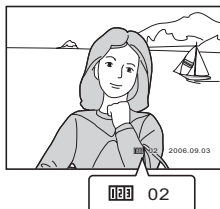

Two days elapsed since the specified date

Shot Confirmation



The shot confirmation LED will light after shooting to confirm that the shot has been taken.

Off (default setting)	The shot confirmation LED will not light after shooting.
On	The shot confirmation LED will light after shooting. When Multi-shot 16 or 5 shot buffer is selected for Continuous , the lamp will light after all pictures in the series have been taken. The lamp will not light when Ultra HS is selected or if the flash is fired when shooting.

AF Assist



The built-in AF-assist illuminator will light when the shutter-release button is pressed halfway, allowing the camera to focus even when the subject is poorly lit.

Off	The AF-assist illuminator will not light. Select Off when the AF-assist illuminator is too bright for subjects or flash photography is prohibited. If the AF-assist illuminator is turned off when shooting in poor lighting, the camera may not be able to focus accurately.
Auto (default setting)	The AF-assist illuminator will light when the shutter-release button is pressed halfway. The camera focuses on the subject even when the subject is poorly lit.











AF-Assist Illuminator Range

Zoom out : Approx. 0.5 - 3.0 m (1 ft. 8 in. - 9 ft. 10 in.)

Zoom in : Approx. 0.5 - 1.5 m (1 ft. 8 in. - 4 ft. 11 in.)

AF-Assist Illuminator

When **AF assist** is set to **Auto**, the AF-assist illuminator will light in the following cases:

- **AF area mode** is set to **Auto** or **Center** in the Shooting menu.
- The center focus area is selected when **AF area mode** is set to **Manual**.
- When shooting in  **PORTRAIT (FACE AF)**,  **PORTRAIT**,  **PARTY/INDOOR**,  **NIGHT PORTRAIT**,  **BEACH/SNOW**,  **COPY**,  **SPORTS**,  **BACK LIGHT**, or  **PANORAMA ASSIST** mode.
- The center focus area is selected in  **CLOSE UP** mode.

Sound Settings



You can set the button sound on/off and select the volume of shutter and start-up sounds.

Button sound	When On is selected, a beep will sound once when operations are completed successfully, three times when an error is detected.
Shutter sound	Set the volume of the shutter sound to Loud , Normal or Off .
Start-up sound	Set the volume of the sound played when the camera is turned on to Loud , Normal or Off .

Auto Off



The monitor turns off automatically and the camera enters Standby mode to save power if no operations are performed for a specified length of time. You can select thirty seconds (**30s**), one minute (**1m**, default setting), five minutes (**5m**) or thirty minutes (**30m**). If no operations are performed in Standby mode for another three minutes, the camera will turn off automatically.

Format Memory/Card



Use this option to format the internal memory or memory card.

- To format the internal memory, remove the memory card from the camera. **Format memory** appears in the Set-up menu.
- When the memory card is inserted in the camera, **Format card** appears in the Set-up menu.

Quick format	Formats only the areas with recorded data. All pictures will be erased.
Format (For memory card only)	Formats the entire memory card including areas with no recorded data. All pictures will be erased. Format takes longer than Quick format .



Notes on Formatting Memory/Card

- During formatting, do not turn the camera off or remove the battery or memory card.
- Format new memory cards with the **Format** option before recording pictures on them.
- Shooting and deleting pictures repeatedly without regular formatting reduces the performance of memory cards. We recommend formatting memory cards regularly to maintain their performance.
- **Format** is not available when the battery level is low.

Language



You can select the language for menus and messages displayed on the monitor.

Čeština	Czech
Dansk	Danish
Deutsch	German
English	(default setting)
Español	Spanish
Français	French
Indonesia	Indonesian
Italiano	Italian
Nederlands	Dutch
Norsk	Norwegian

Polski	Polish
Português	Portuguese
Русский	Russian
Suomi	Finnish
Svenska	Swedish
中文简体	Simplified Chinese
中文繁體	Traditional Chinese
日本語	Japanese
한국	Korean
ภาษาไทย	Thai





Interface (USB/Video Mode)

Use this option to change the interface settings for connecting the camera to a computer, printer, or video device.



USB	Select Mass storage or PTP for connecting to a computer or printer (P.64).
Video mode	Select NTSC or PAL to match the video standard used in the connected device (P.61).

Auto Transfer

When **Auto transfer** is set to **On**, all pictures are automatically marked with the  icon after shooting and set for transferring.

 Off	Pictures are not marked with the  icon after shooting.
 On (default setting)	Marks all pictures with the  icon and sets them for transferring.

The Transfer Marking Icon

When the camera is connected to a computer via the UC-E6 USB cable (P.62), the pictures marked with the  icon will be transferred automatically by pressing **[OK]**. When connected via an access point, select **Marked Images** in the **WIRELESS MENU**, then press **[OK]** to transfer pictures with the  icon.

The Icon on Stored Pictures

Use the **Transfer marking** option (P.95) in the Playback menu to add or remove the  icon on stored pictures.

Reset All



The camera settings will be restored to the default settings.

Resetting File Numbering to 0001

To reset the file numbering to 0001, perform **Reset all** after deleting all pictures (P.94) or formatting the internal memory or memory card (P.106).

For more information, see “Default Settings” (P.143).

Firmware Version



Use this option to check the firmware version for the camera. The 12-digit number displayed below the firmware version is the camera’s MAC address.

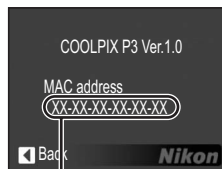

MAC address

Wireless Transfer Mode

What is Wireless Transfer Mode?

Wireless transfer mode, which is based on the IEEE 802.11b/g standard, is a communication feature that allows you to wirelessly connect to a Wi-Fi-enabled computer so that you can transfer and print pictures. You can even use the optional PD-10 wireless printer adapter to wirelessly connect to a printer and print pictures directly.

Wireless transfer mode supports both “ad-hoc” and “infrastructure” modes.

Ad-hoc Mode

This mode establishes a peer-to-peer (one-to-one) connection between the camera and computer.



Infrastructure Mode

This mode connects the camera and computer via a wireless LAN access point.

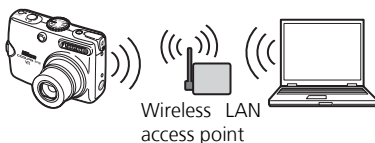

The Optional PD-10 Wireless Printer Adapter

Using the optional PD-10 wireless printer adapter, you can wirelessly transfer pictures directly from the camera to a PictBridge-compatible printer and print.



Supported Operating Systems

The following operating systems have been tested and approved for use with Wireless transfer mode:

- Windows XP Professional/Home Edition (SP1 or later; SP2 is recommended)
- Mac OS X (10.3 or later)

The latest information on supported operating systems is available online at the sites listed under “Life-Long Learning” (P.11).

Setting Up Wireless Transfer Mode

Use the supplied Wireless Camera Setup Utility (hereafter Setup Utility) to configure your computer as a “profile device” in the camera. Before starting, see “Configuration Procedure” (P.112) for more information on configuring a profile device. **The Wireless Camera Setup Utility/PictureProject Installer CD (hereafter CD-ROM) supplied with the camera is required for installation.**

Confirming the Type of Configuration

When configuring the computer as a profile device using the Setup Utility, the type of configuration based on the wireless LAN settings in your computer is displayed. Before starting the Setup Utility, consult the following table and select the type of configuration you will use.

Type	When to use
Create an Infrastructure (Access Point) network profile	Select when using the existing infrastructure network settings in your computer.
Create Infrastructure (Access Point) and Ad-hoc (Camera to Computer) network profile	Select when using multiple wireless networks.
Create an Ad-hoc (Camera to Computer) network profile	Select when establishing a peer-to-peer connection between the camera and computer. This type is recommended for first-time users of wireless networks.*
Create Profile manually	Select if your computer has a fixed IP address, does not have a wireless network set up using Windows XP's built-in wireless network features, runs Windows XP SP1, or is a Macintosh. This type is recommended for power users.

* **Create an Ad-hoc (Camera to Computer) network profile** cannot be selected if an infrastructure network has already been set up in your computer, or the fixed IP address is not 169.254.x.x.

Select the type of configuration after the Setup Utility verifies the wireless network settings in your computer. For more information, see “Configuration Procedure” (P.112).

Checking that Setup Utility is Installed

The Setup Utility is installed with PictureProject from the CD-ROM supplied with the camera.

Follow the steps below to check that the Setup Utility is installed on the computer that will be set as a profile device.

- Windows: Select **Start** → **All Programs** and check whether the Setup Utility is installed.
- Macintosh: **Applications** folder → open the **Wireless Camera Setup Utility** folder in the **Nikon Software** folder and check whether the Setup Utility is installed.

When the Setup Utility is Already Installed

If the Setup Utility is installed, select or double-click the program icon to run.

A window with three tabs (**Get Started**, **Profiles** and **Wireless Printing**) appears. Select **Get Started** and click **Next** (P.114).



When the Setup Utility is Not Installed

Install the software using the CD-ROM. Select **Easy Install** (the Setup Utility is installed after PictureProject is installed) or **Wireless Setup Only** (only the Setup Utility is installed) in the **Install Center** window of the installation wizard.

Select the display language for the Setup Utility in the language selection window. The Setup Utility starts automatically after installation (a screen without three tabs appears). Configure the computer as a profile device (P.114).



(Not applicable in some areas)



Installation

See the *Quick Start Guide* or *PictureProject Reference Manual* (on CD) for more information on installing the Setup Utility.

Configuration Procedure

After starting the Setup Utility, perform the following steps to configure a profile device.

- For more information on the procedure below, see “Configuration Details” (P.114).
- For more information on the options for steps 5 and 6 when selecting **Create Profile manually**, see “Information about Profile Configuration” (P.118).
- Click **Help** to display more information on each step. To cancel configuring a profile device, click **Cancel** in a window.

○ : Perform step — : Skip step

1 Confirm that your camera’s battery is inserted and fully charged.

2 Confirm that your computer supports wireless networking.

3 Confirm that camera is connected to computer via USB cable.

4 Select type of configuration from options that are displayed.
If your computer has a fixed IP address, does not have a wireless network set up using Windows XP’s built-in wireless network features, runs Windows XP SP1, or is a Macintosh, the Setup Utility automatically goes to **Create Profile manually**.

Create an Infrastructure (Access Point) network profile	Create an Ad-hoc (Camera to Computer) network profile	Create Infrastructure (Access Point) and Ad-hoc (Camera to Computer) network profile	Create Profile manually
↓	↓	↓	↓

5 Set profile name and icon.

○

○

○

○

↓

↓

↓

↓

Create an Infrastructure (Access Point) network profile	Create an Ad-hoc (Camera to Computer) network profile	Create Infrastructure (Access Point) and Ad-hoc (Camera to Computer) network profile	Create Profile manually
---------------------------------------------------------	-------------------------------------------------------	--------------------------------------------------------------------------------------	-------------------------

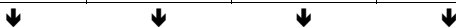

6 Enter network settings.	<input type="radio"/>	—	<input type="radio"/> *	<input type="radio"/>
	(enter available items only)		(enter available items only)	

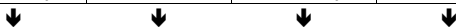

7 Configure TCP/IP.	—	—	—	<input type="radio"/>

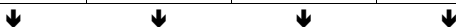

8 Configure wireless printing.	<input type="radio"/>	<input type="radio"/>	<input type="radio"/>	<input type="radio"/>

* After step 6, repeat procedure from step 5 of **Create an Ad-hoc (Camera to Computer) network profile**. After the ad-hoc network is set up, wireless printing is configured.

✓ When “Create an Ad-hoc (Camera to Computer) network profile” is Selected

After you follow the steps on page 112 to set up an ad-hoc network and configure a profile device, a fixed IP address will be set in your computer. If an infrastructure network will be added later, set your computer to automatically obtain an IP address before adding. To add the network, connect the camera and the computer via a USB cable, start the Setup Utility and then create a new profile.

Configuration Details

1 Confirm that your camera's battery is inserted and fully charged.

After connecting the camera and computer using the supplied UC-E6 USB cable and confirming the following, click **Next**.

- The battery is fully charged or the optional EH-62A AC adapter kit is used. (Profile devices cannot be configured if the camera turns off while setting.)
- **USB** option is set to **PTP**.
- The mode dial is set to **SET UP**.



2 Confirm that your computer supports wireless networking.

If a wireless LAN adapter is installed in your computer, click **Next**.

- If selecting **Create an Infrastructure (Access Point) network profile**, **Create Infrastructure (Access Point) and Ad-hoc (Camera to Computer) network profile** or **Create Profile manually**, confirm that your computer is connected to a wireless network.



3 Confirm that camera is connected to computer via USB cable.

The Setup Utility checks that the camera is connected to the computer via a USB cable.

- If the camera is not connected to the computer, an alert message appears. After connecting them correctly, click **Next**.



4 Select type of configuration from options that are displayed. The Setup Utility shows types of configuration based on the wireless LAN settings in your computer. The following procedure differs depending on the selection.

- If your computer has a fixed IP address, does not have a wireless network set up using Windows XP's built-in wireless network features, runs Windows XP SP1, or is a Macintosh, complete the settings for **Create Profile manually**. Neither screen below is displayed.

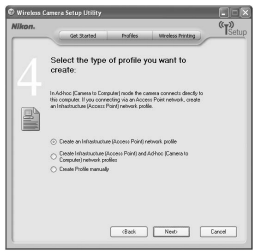

If an infrastructure network is set up in the computer

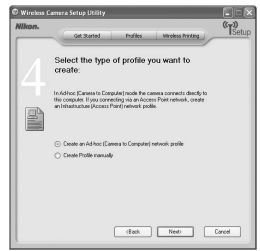

If no wireless networks are set up in the computer

- If more than one wireless LAN adapter is installed in the computer, choose an adapter from the list. The types of configuration are displayed based on the adapter. Select the desired type.
- The numbers that appear on the screens in step 5 and after depend on the type of configuration selected in step 4.

5 Set profile name and icon. Enter a profile name (up to 16 single-byte alphanumeric) that will appear in the **CHOOSE PROFILE** screen (P. 122), select an icon and click **Next**.

- We recommend selecting a name that will let you easily tell devices apart, such as "Desktop-Home".

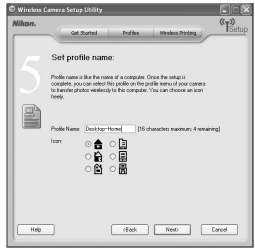

6 Enter network settings.

Enter the settings for connecting the camera and the computer via a wireless network.

- When selecting **Create an Infrastructure (Access Point) network profile** or **Create Infrastructure (Access Point) and Ad-hoc (Camera to Computer) network profile**, select a network name from the **Network Name (SSID)** list that will be used for connecting the camera and the computer. If necessary, use the same values set in the access point for other items.

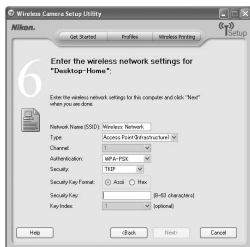

- When selecting **Create an Ad-hoc (Camera to Computer) network profile**, this step is unnecessary.
- When selecting **Create Profile manually**, enter the same values set in the access point for all items manually except those that are automatically provided.

7 Configure TCP/IP.

Configure the items below only if selecting **Create Profile manually**.

- Configure:**

Select **Auto** or **Manual** for the method of setting the camera IP address (required).

- IP Address:**

When **Configure** is set to **Manual**, enter the IP address for the camera.

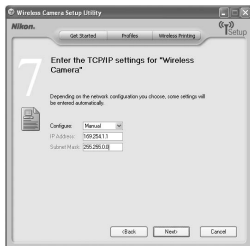

8 Configure wireless printing.

If a printer is connected to the computer, select the printer to be used for wireless printing (P.130), enter a printer profile name and select a printer icon.

- When selecting **Create Infrastructure (Access Point) and Ad-hoc (Camera to Computer) network profile**, the Setup Utility automatically returns to the screen in step 5 without configuring a printer, and a new ad-hoc network is set up in the computer. After this network profile is set up, wireless printing is configured.
- For Macintosh, click **Select Printer...** in the **Get Started** tab of the Setup Utility and select a printer. After this, you can select printer settings such as paper type and print quality.
- If no printers are connected to the computer, click **Next** without selecting a printer.



✓ Wireless Printing Profiles

Whether a printer is connected to the computer or not, after configuring a profile, two profiles (one for the computer and one for the printer) are created in the camera. If wireless printing is not needed, the profile for the printer can be deleted. Connect the camera and computer via a USB cable, start the Setup Utility and then delete the profile for the printer (P.120).

Information about Profile Configuration

Configuration of Profile Devices

Every computer that will connect to the camera must be configured as a profile device.

Maximum Number of Profile Devices

You can configure a maximum of nine profile devices (computers, printers connected to a computer, the optional PD-10 wireless printer adapter) in the camera. If nine have already been configured and you want to add a new one, delete an unneeded profile device using the Setup Utility (P.120).

Checking the Computer Wireless LAN Settings

Check the following items on the computer before starting the Setup Utility and configuring a profile device. Refer to the manual and other reference materials for your computer and wireless LAN devices.

Network Name (SSID)	Enter the network ID for the computer.
Type	Select Camera to Computer (Ad-hoc) or Access Point (Infrastructure) . The camera and the computer must be set to the same option.
Channel	Select the same channel (1 to 11) set in the computer (Camera to Computer (Ad-hoc) only).
Authentication	Select Open, Shared or WPA-PSK (Access Point (Infrastructure)) only). Select the same method set in the computer.
Security	Select None, WEP 64 bits, WEP 128 bits or TKIP (Access Point (Infrastructure)) only). Select the same method set in the computer.
Security Key Format	When Security is set to WEP 64 bits or WEP 128 bits , select the same method set in the computer (unnecessary when Security is set to None).
Security Key	Enter the security key set in the computer (unnecessary when Security is set to None).
Key Index	When Security is set to WEP 64 bits or WEP 128 bits , select the same key index set in the computer (unnecessary when Security is set to None). The default setting is 1 .
Configure	Select Auto or Manual for the method of setting the camera IP address.
IP Address	When Configure is set to Manual , enter the IP address for the camera.

Authentication and Security for Wireless Transfer

The following combinations are available on this camera (AES is not available).

Authentication	Open	Shared	WPA-PSK
Security	None/WEP	WEP	TKIP

The security levels from lowest to highest are None, WEP and TKIP. Changing the security method may lower the security level.

MAC Address Filtering

When MAC address filtering is enabled, only devices with an authorized MAC address can access the wireless LAN. Check the camera's MAC address (P.108) and add it to the authorized list.

Port Number

For wireless communication, the UDP port number is 5353 and the TCP port number is 15740. If the computer or access point has a firewall, the firewall settings may need to be changed.

Confirming Profiles

A profile is information about a profile device and is stored in the camera. You can use the Setup Utility to view or delete profiles saved in the camera, or edit a profile name.

1 Start Setup Utility.

2 Select **Profiles** tab.

Select the desired profile name from the list. To check a profile, click **View Profile**. To edit a profile name, click **Rename**. To delete a profile, click **Delete**.



Transferring Images to a Computer

Using Wireless Transfer Mode

Wirelessly transfer images to a computer or print images using the functions below.

Easy Transfer	Transfer images in the internal memory or on the memory card not already in the computer.	P.124
Shooting Date	Transfer images taken on a specific recording date.	P.125
Marked Images	Transfer only those images with a transfer mark (📶) (P.95).	P.126
Selected Images	Transfer only selected images.	P.127
Shoot & Transfer	Transfer recorded images immediately. Images can also be stored in the internal memory or on the memory card.	P.128
PC Mode	Transfer images to a profile device using a computer with PictureProject.	P.129
Wireless Printing	Print images from a printer connected to a computer.	P.130
	Using the optional PD-10 wireless printer adapter, you can print by wirelessly transferring images to a PictBridge-compatible printer.	P.131



Sound Settings

When using Wireless transfer mode, all sounds are turned off regardless of the sound settings (P.105).



Mode Dial Use During Wireless Connection

Rotating the mode dial disconnects the connection and stops image transfer.



Note on Standby Mode

If no operations are performed for approximately three minutes, the camera will enter Standby mode and the monitor will turn off automatically. During Standby mode, image transfer will still continue.



Memory Card Write Protection

When the memory card switch is in the “lock” position, images cannot be transferred (except during **PC Mode**). Slide the switch to the “write” position before transferring images (P.21).

Transferring Images to a Computer

Displaying the WIRELESS MENU:

1

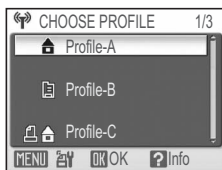

Rotate mode dial to  and turn camera on.

- The **CHOOSE PROFILE** screen is displayed and the most recently used profiles are shown first. (The screens in steps 1 and 2 are examples. The profile device (P.115) names set in the Setup Utility will be displayed.)
- Press  (Info) on the **CHOOSE PROFILE** screen to display the SSID of the selected profile and the type of device. If the camera cannot connect to the profile device, you can check whether the profile settings and the settings saved in the camera match.

2

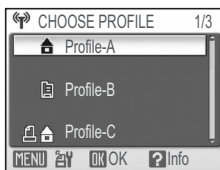



Highlight profile.

3



Display **WIRELESS MENU**.

This menu appears after a wireless connection is established.

- For Macintosh, when using ad-hoc mode, press  and click **AirPort** in the Mac OS X menu bar to display the menu. Select the profile device selected in step 2 to establish the connection.
- Press  before connection is established to return to the **CHOOSE PROFILE** screen.

4



Highlight option for transferring images.

- See pages 124 to 129 for more information on each menu option.

✓ Signal Indicator

The signal strength is represented by a five-level indicator on the monitor. When the camera is outside the range of the signal, the indicator is displayed in red. If the signal strength is weak, remove any obstacles between the camera and computer.

✓ If an Error Occurs

When the connection to a profile device or the connection after selecting **WIRELESS MENU** has not been established, the error messages at right are displayed. Check the selected computer or access point and resolve the error. Select **Try Again** to reconnect. Select **Choose Profile** to cancel the connection and return to the **CHOOSE PROFILE**

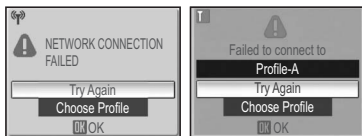

screen. If **Try Again** cannot be selected due to the error, select **Choose Profile**.

✓ Wireless Transfer LED

The wireless transfer LED (P.13) indicates the wireless transfer status.

Blinks : Searching for profile device.

Lights : Connected to profile device or transferring data.

Off : Not connected.

In order to reduce power consumption, the wireless transfer LED may switch to blinking status if no data is transmitted within a set period of time based on operating conditions.

✓ Resuming Interrupted Transfers

If image transfer is interrupted due to a low battery level, etc., images can be sent again. Select **Yes** when the message "Resume interrupted transfer?" is displayed during Wireless transfer mode. Select **No** to cancel image transfer.

✓ Ⓞ Button

In Wireless transfer mode, Ⓞ is used only to perform menu operations. Pressing Ⓞ does not transfer images with 📡 (transfer mark), unlike when using PictureProject with a USB connection (P.62). See pages 121 to 129 for more information on transferring images using Wireless transfer mode.

✓ Optional Wireless Printer Adapter

When **MENU** is pressed in the **CHOOSE PROFILE** screen, the optional PD-10 wireless printer adapter can be selected as a profile device. See the manual for the wireless printer adapter for more information.

Transferring Images Not in a Computer: Easy Transfer

1



Highlight **Easy Transfer** in **WIRELESS MENU**.

2



Transfer images.

Press **OK** to transfer images not already in the computer.

3



Message is displayed when transfer is complete.

- Press **OK** to return to the **CHOOSE PROFILE** screen.
- To end Wireless transfer mode, rotate the mode dial to a different setting.

✓ Checking Connection with Profile Device

In Wireless transfer mode, highlight an item and press **OK** to display the screen to check the status. After this screen is displayed, the operations of the different transfer modes can be performed.

- Press **OK** while this screen is displayed to return to the **CHOOSE PROFILE** screen.



✓ Save Location of Transferred Images

- Images transferred to the computer (P.124 - 129) are saved to the following location.
Windows XP : **PictureProject** folder in **My Pictures** folder
Macintosh : **PictureProject** folder in **Picture** folder
- When images are transferred with a computer that has PictureProject installed (except during **PC Mode**) (P.124 - 128), PictureProject automatically starts and displays the transferred images. The save location can be changed.
- For computers without PictureProject installed, Explorer (for Windows) or Finder (for Macintosh) starts and displays the save location. The save location cannot be changed.
- If the camera is connected to a computer in **PC Mode** (P.129) without PictureProject installed, drag and drop images from the camera icon or drive displayed on the computer to the desired save location.

Transferring Images by Specific Recording Date: Shooting Date

1



Highlight **Shooting Date** in **WIRELESS MENU**.

2

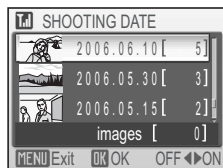

Display **SHOOTING DATE** screen. This screen appears after the connection confirmation screen (P.124) is displayed.

3

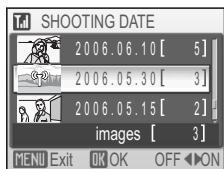

Highlight shooting date of images to be transferred.

Press the multi selector right and the icon (Wireless transfer) appears on selected date.

- Select all recording dates for images to be transferred.
- Press the multi selector left to cancel setting.

4

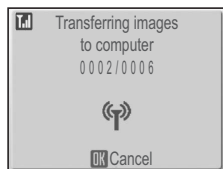

Transfer images.

5

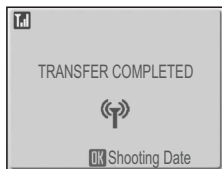

Message is displayed when transfer is complete.

- Press to return to the **CHOOSE PROFILE** screen.
- To end Wireless transfer mode, rotate the mode dial to a different setting.

When Using Shooting Date

Pictures with no date set (P.22, 100) cannot be transferred using the method above.

Transferring Images with Transfer Mark: Marked Images

1



Highlight **Marked Images** in **WIRELESS MENU**.

2

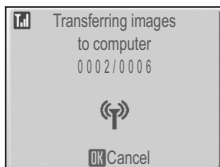

Transfer images.

Press **OK** to transfer images with the transfer mark  (P.95) after the connection confirmation screen (P.124) is displayed.





3

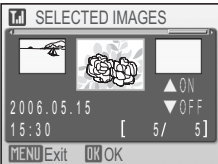
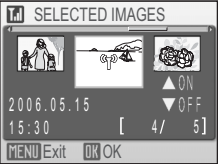

Message is displayed when transfer is complete.

- Press **OK** to return to the **CHOOSE PROFILE** screen.
- To end Wireless transfer mode, rotate the mode dial to a different setting.





Selecting and Transferring Images: Selected Images

<p>1</p>  <p>Highlight Selected Images in WIRELESS MENU.</p>	<p>2</p>  <p>Display SELECTED IMAGES screen. This screen appears after the connection confirmation screen (P.124) is displayed.</p>
<p>3</p>  <p>Select pictures for transfer. The  mark (Wireless transfer) appears on the selected images.</p> <ul style="list-style-type: none">• Select all images to be transferred.• Press the multi selector down to cancel setting.	<p>4</p>  <p>Transfer images.</p>
<p>5</p>  <p>Finish transfer.</p> <ul style="list-style-type: none">• Press OK to return to CHOOSE PROFILE screen.• To end Wireless transfer mode, rotate the mode dial to a different setting.	

The Wireless Transfer Mark

The  mark that appears on images in step 3 disappears after transfer. The image is no longer selected after returning to the **CHOOSE PROFILE** screen.

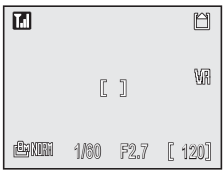
Immediately Transferring Recorded Images: Shoot & Transfer

<p>1</p>  <p>Highlight Shoot & Transfer in WIRELESS MENU.</p>	 <p>WIRELESS MENU 1/2 Easy Transfer Shooting Date Marked Images Selected Images Shoot & Transfer OK OK ? Help</p>	<p>2</p>  <p>Display Shooting screen. This screen appears after the connection confirmation screen (P.124) is displayed.</p>
<p>3</p>  <p>Transferring images to computer OK Cancel</p>	<p>Take picture. When the picture is taken, the image is transferred to the computer. After the image is transferred, the camera returns to the Shooting screen. Additional pictures cannot be taken until transfer is complete.</p> <ul style="list-style-type: none">• If the transfer confirmation dialog is displayed, select Yes. Select No to cancel image transfer.	

Changing the Settings

Press **MENU** while the camera is in Shooting mode to display the **SHOOT & TRANSFER** screen and make the following changes.

Confirm Transfer	Off	Immediately transfers recorded image to the computer.
	On	Displays the transfer confirmation dialog prompting whether to transfer the recorded image to the computer each time a picture is taken.
Save Images	Off	Saves the recorded image only to the computer and not to the internal memory or memory card.
	On	Saves the recorded image to the internal memory or memory card.

If **Save Images** is set to **Off** and an error occurs during the **Shoot & Transfer** operation, the picture is not saved. Saving important pictures is recommended.

✓ Other Functions During Shooting

When **Shoot & Transfer** is enabled, **TV** mode (P.24) is enabled. If the mode dial is rotated while in Wireless transfer mode, the connection will be interrupted, so set Image mode (P.43) before starting **Shoot & Transfer**.

Transferring Images Using a Computer: PC Mode

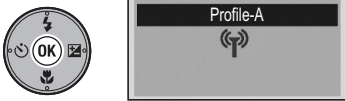
<p>1</p>  <p>Highlight PC Mode in WIRELESS MENU.</p>	<p>2</p>  <p>Connect to computer. The PictureProject Transfer screen is displayed on the computer screen. Click Transfer in PictureProject to transfer images.</p>
------------------------------------------------------------------------------------------------------------------------------------------------------------	---------------------------------------------------------------------------------------------------------------------------------------------------------------------------------------------------------------------------------------------------------------------------

When Multiple Computers Share the Same SSID

If the camera has stored the profiles of multiple devices with the same network name (SSID) and those devices are started, the camera connects only to the profile device specified in the **CHOOSE PROFILE** screen (P.122).

Notes on PC Mode

Perform all transfer operations from the computer.

- Use PictureProject Transfer when using PictureProject.
- To transfer without using PictureProject, drag and drop the image from the camera icon or drive displayed on the computer to the desired save location.

Transferring Images to a Printer

Printing Images from a Printer Connected to a Computer: Wireless Printing

1

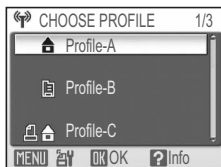

Rotate mode dial to and turn camera on.

- The **CHOOSE PROFILE** screen is displayed and the most recently used profiles are shown first.
- Press (Info) on the **CHOOSE PROFILE** screen to display the SSID of the selected profile and type of device. If the camera cannot connect to the profile device, you can check whether the profile settings and the settings saved in the camera match.

2

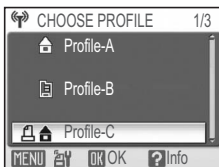

Highlight profile (profile device with printer icon).

3

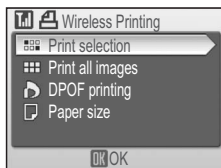
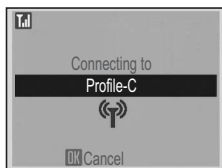

Select pictures for transfer and print.

After the Wireless transfer connection screen is displayed, the **Wireless Printing** is displayed. Pictures can be selected and printed in the same manner as steps 2 to 5 on pages 70 and 71.

Note on Printing via Wireless LAN

In infrastructure mode, only printers on the same network as the computer can be used. Printers on other networks connected via a router (a network with a different access point) cannot be used.



When Multiple Printers are Connected to a Computer

Start the Setup Utility on the computer. Select the **Wireless Printing** tab and select the desired printer (P.120).



Transferring Images Directly to a Printer: PD-10 Wireless Printer Adapter

Using the optional PD-10 wireless printer adapter, you can wirelessly transfer pictures directly from the camera to a PictBridge-compatible printer and print them.

For more information, see the manual for the adapter.

Optional Accessories

The following optional accessories are available for your Nikon digital camera. Contact your local retailer or Nikon representative for details.

Rechargeable battery	Additional EN-EL5 Li-ion batteries
Battery charger	MH-61 battery charger
AC adapter	EH-62A AC adapter kit
Carrying case	CS-CP18 soft case
Wireless printer adapter	PD-10 wireless printer adapter

Approved Memory Cards

The following memory cards have been tested and approved for use:

SanDisk	64 MB, 128 MB, 256 MB, 512 MB, 1 GB / 256 MB*, 512 MB*, 1 GB*
Toshiba	64 MB, 128 MB, 256 MB, 512 MB, 1 GB / 128 MB*, 256 MB*, 512 MB*
Panasonic	64 MB, 128 MB, 256 MB, 512 MB, 1 GB / 256 MB*, 512 MB*, 1 GB*

* Cards rated for 10 MB/s.

- Other memory cards have not been tested. For more details on the cards listed above, please contact the manufacturer.

Notes on Memory Cards

- Use only Secure Digital (SD) memory cards.
- Format new memory cards before first use (P.106).
- Turn the camera off when inserting or removing a memory card.
- Do not eject the memory card, turn the camera off, remove the battery, or disconnect the AC adapter during formatting or while data is being written to or deleted from the card. Failure to observe this precaution could result in loss of data or damage to the camera or card.
- Do not disassemble or modify.
- Do not drop, bend, or expose to water or strong physical shocks.
- Do not touch the metal terminals with your fingers or metal objects.
- Do not affix labels or stickers to the memory card.
- Do not leave in direct sunlight in a closed vehicle or in other areas exposed to high temperatures.
- Do not expose to high levels of humidity or to corrosive gas.

Caring for Your Camera

To ensure continued enjoyment of your Nikon product, observe the following precautions when storing or using the device.



Keep dry

The device will be damaged if immersed in water or subjected to high levels of moisture.



Handle the lens and all moving parts with care

Do not apply force to the lens, monitor, or to the connector, card slot, or battery chamber or lens covers. These parts are especially susceptible to damage. Applying force to the lens cover could result in camera malfunction or damage to the lens.



Do not point the lens at strong light sources for extended periods

Avoid pointing the lens at the sun or other strong light sources for extended periods when using or storing the camera. Intense light may cause deterioration in the CCD image sensor, producing a white blur effect in photographs.



Turn the product off before removing or disconnecting the power source

Do not unplug the product or remove the battery while the product is on, or while images are being recorded or deleted. Forcibly cutting power in these circumstances could result in loss of data or in damage to product memory or internal circuitry. To prevent an accidental interruption of power, avoid carrying the product from one place to another while the AC adapter is connected.



Do not drop

The product may malfunction if subjected to strong shocks or vibration.



Keep away from strong magnetic fields

Do not use or store this device in the vicinity of equipment that generates strong electromagnetic radiation or magnetic fields. Strong static charges or the magnetic fields produced by equipment such as radio transmitters could interfere with the monitor, damage data stored on the memory card, or affect the product's internal circuitry.



Avoid sudden changes in temperature

Sudden changes in temperature, such as occur when entering or leaving a heated building on a cold day, can cause condensation inside the device.

To prevent condensation, place the device in a carrying case or a plastic bag before exposing it to sudden changes in temperature.



The AF-Assist Illuminator LED

The light-emitting diode (LED) used in the AF-assist illuminator (P.104) conforms to the following IEC standard:

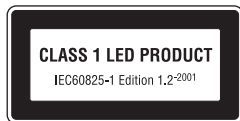

Cleaning

Lens

One key to preserving the condition of glass parts is to not touch them with your fingers. Remove dust or lint with a blower (typically a small device with a rubber bulb attached to one end that is pumped to produce a stream of air out the other). To remove fingerprints or other stains that cannot be removed with a blower, wipe the lens with a soft cloth, using a spiral motion that starts in the center of the lens and works out to the edges. If this fails to clean the lens, wipe with a dry cloth lightly dampened with commercial lens cleaner.

Monitor

Remove dust or lint with a blower. To remove fingerprints and other stains, clean the monitor with a soft, dry cloth, being careful not to apply pressure.

Body

Use a blower to remove dust, dirt, or sand then wipe gently with a soft, dry cloth. After using the camera at the beach or seaside, wipe off any sand or salt with a dry cloth lightly dampened with fresh water, then dry thoroughly. The camera may be damaged if foreign matter gets inside the camera body. Nikon cannot accept liability for damage caused by dirt or sand.

Do not use alcohol, thinner, or other volatile chemicals.



Avoid Contact with Liquid Crystal

Should the monitor break, care should be taken to avoid injury due to broken glass and to prevent the liquid crystal from the monitor touching the skin or entering the eyes or mouth.



Notes on the Monitor

- The monitor may contain a few pixels that are always lit or that do not light. This is a characteristic common to all TFT LCD monitors, and does not indicate a malfunction. Images recorded using the product will not be affected.
- When you frame bright subjects, vertical comet-like streaks that whiten toward either end may appear on the monitor. This phenomenon, known as “smear”, does not appear in the final photograph and does not indicate a malfunction. Some smear may appear in movies.
- Images on the monitor may be difficult to see in a bright light.
- The monitor is lit by an LED backlight. Should the monitor begin to dim or flicker, contact your local retailer or Nikon representative.

Storage

Turn the camera off when not in use and check that the power-on lamp is off before putting the camera away. To prevent mold or mildew, store the camera in a dry, well-ventilated area. If the product will not be used for an extended period, run the battery flat and remove it from the camera. Store the camera in a plastic bag containing a desiccant, replacing the desiccant when it loses its capacity to absorb moisture. Do not store your camera with naphtha or camphor moth balls or in locations that:

- are poorly ventilated or subject to humidities of over 60%.
- are next to equipment that produces strong electromagnetic fields, such as televisions or radios.
- are exposed to temperatures below -10°C (14°F) or above 50°C (122°F).

To prevent mold or mildew, take the camera out of storage at least once a month. Turn the camera on and release the shutter a few times before putting the camera away again.























Batteries













- Check the battery level when taking the camera out and charge the battery if necessary. Do not continue charging once the battery is fully charged, as this will result in reduced battery performance. If possible, carry a fully-charged spare battery when taking pictures on important occasions.
- Do not use the battery at ambient temperatures below 0°C (32°F) or above 40°C (104°F). During charging, the temperature should be in the vicinity of $5 - 35^{\circ}\text{C}$ ($41 - 95^{\circ}\text{F}$). Note that the battery may become hot during use; wait for the battery to cool before charging. Failure to observe these precautions could damage the battery, impair its performance, or prevent it from charging normally.
- On cold days, the capacity of batteries tends to decrease. Be sure that the battery is fully charged before heading outside to take pictures in cold weather. Keep spare batteries in a warm place and exchange as necessary. Once warmed, a cold battery may recover some of its charge.
- Dirt on the battery terminals can prevent the camera from functioning.
- When the battery is not in use, remove it from the camera or battery charger and replace the terminal cover. The camera and battery charger draw minute amounts of current even when off; if left in place, the battery could be drained to the point that it no longer functions. Turning the camera on or off while the battery is exhausted can result in reduced battery life. If the battery will not be used for an extended period, store it in a cool ($15 - 25^{\circ}\text{C}$ / $59 - 77^{\circ}\text{F}$), dry place. Recharge it at least once a year and run it flat before returning it to storage.
- Replace the battery when it no longer holds a charge. Used batteries are a valuable resource. Please recycle used batteries in accordance with local regulations.

Error Messages

The following table lists the error messages and other warnings that appear on the monitor and how to deal with them.

Display	Problem	Solution	Page
 (Flashes)	Clock not set.	Set clock.	P.22
WARNING!! BATTERY EXHAUSTED 	Battery exhausted.	Turn camera off and replace battery.	P.16
[] AF● (flashes red)	Camera cannot focus.	Use AF lock to focus on another subject at same distance, then recompose picture.	P.87
WARNING!! PLEASE WAIT FOR THE CAMERA TO FINISH RECORDING 	<ul style="list-style-type: none"> • Camera turned off during recording. •  pressed during recording. • Mode dial rotated to another mode during recording. 	Message clears from monitor automatically when recording is complete.	P.26
MEMORY CARD IS WRITE PROTECTED. 	Write-protect switch of memory card is in "lock" position.	Slide write-protect switch to "write" position.	P.21
THIS CARD CANNOT BE USED 	Error accessing memory card.	<ul style="list-style-type: none"> • Use approved card. • Check that connectors are clean. • Turn camera off and confirm that memory card is correctly inserted. 	P.132
WARNING!! THIS CARD CANNOT BE READ 			P.20
CARD IS NOT FORMATTED  Format No	Memory card has not been formatted for use in camera.	Press multi selector up to highlight Format and press  to format card, or turn camera off and replace card.	P.21, P.106
OUT OF MEMORY  or 	<i>Camera in the shooting mode:</i> Insufficient memory to record pictures at current settings.	<ul style="list-style-type: none"> • Choose new image mode. • Delete pictures. • Remove memory card and use internal memory or insert new memory card. 	P.43 P.27, P.94 P.20
	<i>Camera connected to computer.</i> Not enough memory to record information needed for transfer.	Delete unwanted pictures and try again.	P.94

Display	Problem	Solution	Page
IMAGE CANNOT BE SAVED  or 	Destination is out of memory for copying picture.	<ul style="list-style-type: none"> Format destination. Insert new memory card or delete unwanted pictures from the internal memory or memory card. 	P.106 P.20, P.27, P.94
	Camera has run out of file numbers.	<ul style="list-style-type: none"> Select Reset all after inserting new memory card. Select Reset all after formatting memory card or internal memory. 	P.20, P.108 P.106
	Invalid picture chosen for creating cropped picture.	Check types of images that can be cropped.	P.54
CANNOT RECORD MOVIE. 	<ul style="list-style-type: none"> Error occurred while saving movie. Takes long time to save movie on memory card. 	<ul style="list-style-type: none"> Format memory card using Format option in the format menu. Insert memory card with faster processing speed. 	P.106 P.20, P.56
MEMORY CONTAINS NO IMAGES 	No pictures in internal memory or memory card.	<ul style="list-style-type: none"> When this message is displayed although pictures are taken, turn camera off and then on again. If error persists, contact your local retailer or Nikon representative. 	P.24
		<ul style="list-style-type: none"> Press  to return to shooting mode. 	P.26
		<ul style="list-style-type: none"> To show pictures in the internal memory, remove memory card from camera. 	P.21
FILE CONTAINS NO IMAGE DATA 	File created by computer or different make of camera.		
ALL IMAGES ARE HIDDEN 	No pictures in the internal memory or on the memory card that can be viewed on the camera.	View file on computer or correct make of camera.	-
THIS IMAGE CANNOT BE DELETED 	Attempt to delete protected picture.	Remove protection before deleting picture.	P.94
NEW CITY IS IN THE CURRENT TIME ZONE 	Travel destination is in same time zone as home location.	No need to specify new time zone if travel destination is in same time zone as home location.	P.100
WARNING! MODE DIAL IS NOT IN THE PROPER POSITION. 	Mode dial is positioned between two modes.	Adjust mode dial to select desired mode correctly.	P.12

Display	Problem	Solution	Page
WARNING!! NO MENU IN AUTO MODE PLEASE USE ANOTHER MODE 	MENU was pressed during  mode.	When the mode dial is set to  , menu cannot be displayed.	–
LENS ERROR 	Error has occurred during lens operation.	Turn camera off and then on again. If error persists, contact local retailer or Nikon representative.	P.24
COMMUNICATIONS ERROR 	USB cable disconnected or memory card removed while images are being transferred to computer.	If error appears on computer monitor, click OK to exit PictureProject. Turn camera off, reconnect cable or replace memory card, then turn camera on and transfer images.	P.20, P.62
	A computer is executing some form of processing.	If error appears on computer monitor, click OK and transfer images after processing has completed.	–
	USB option set incorrectly to transfer images using camera's  (Transfer ) button.	Turn camera off and disconnect cable, then choose new USB setting in the camera Set-up menu and reconnect camera. If error persists, use Transfer button in PictureProject to transfer images.	P.62, P.64, P.66
NO IMAGES ARE MARKED FOR TRANSFER 	No pictures selected for transfer when  (Transfer ) button pressed to transfer images to computer.	<ul style="list-style-type: none"> • Disconnect camera and select at least one picture for transfer, then begin transfer again. • Use Transfer button in PictureProject to transfer images. 	P.62, P.64, P.66
TRANSFER ERROR 	Error occurred when images were transferred to computer.	<ul style="list-style-type: none"> • Check that camera is connected and that battery is fully charged. • Check that optional EH-62A AC adapter kit is firmly connected to the camera. 	P.62 P.24 –
SYSTEM ERROR 	Error has occurred in camera's internal circuitry.	Turn camera off, unplug optional AC adapter (if using), remove and reinsert battery, and turn camera on. If error persists, contact local retailer or Nikon representative.	P.18
PRINTER ERROR  CHECK PRINTER STATUS	Printer error occurred on your printer.	See the manual for the printer and solve the problem.	–

Error Messages During Wireless Transfer Mode

Display	Problem	Solution	Page
Transfer error ⚠	Error occurred when images were transferred to computer.	Check signal. Move the camera closer to the printer. Remove any obstacles between camera antenna and profile device.	-
Profile not registered. Set up profile. ⚠	A profile for wireless transfer has not been set.	Set profile device with Wireless Camera Setup Utility or the optional PD-10 wireless printer adapter.	P.114
⚠ NETWORK CONNECTION FAILED	Camera could not connect to wireless network.	Check selected computer or access point. Check network settings.	P.123
Battery exhausted. Transfer terminated. 🔋	Battery has become depleted while images were being transferred.	Charge battery and turn camera on in Wireless transfer mode.	P.16
⚠ Failed to connect to XXX	Camera could not connect to selected profile device (computer).	Check selected computer.	P.123
Connection error. ⚠	Wireless connection with the profile device stopped while camera was connected to the network.	Check signal. Move the camera closer to the printer. Remove any obstacles between camera antenna and profile device.	-
Failed to register printer profile. ⚠	Printer profile for wireless transfer could not be set.	Check that the printer is on and ready to print.*	-
UNABLE TO CONNECT TO WIRELESS PRINTER ADAPTER. ⚠	Camera could not connect to wireless printer adapter.	Check signal. Move the camera closer to the printer. Remove any obstacles between camera antenna and profile device.	-



* For more information, see the manual for the optional PD-10 wireless printer adapter.

Troubleshooting

If your camera fails to function as expected, check the list of common problems below before consulting your local retailer or Nikon representative. Refer to the page numbers listed in the right-most column for more information.

Electronically-Controlled Cameras

In extremely rare instances, unusual characters may appear on the monitor and the camera may stop functioning. In most cases, this phenomenon is caused by a strong external static charge. Turn the camera off, remove and replace the battery, and turn the camera on again, or, if you are using the optional AC adapter, disconnect and reconnect the adapter, and turn the camera on again. Note that disconnecting the power source as described above may result in the loss of any data not recorded to the internal memory or memory card at the time the problem occurred. Data already recorded to the internal memory or memory card will not be affected.

Problem	Possible cause	Page
Pictures are blurred	<ul style="list-style-type: none">• When shooting a picture or movie, a Vibration reduction option was set by pressing .• Camera shook during shot. Blurring caused by camera shake can be reduced by:<ul style="list-style-type: none">– Using the flash– Using the Best Shot Selector (BSS)– Using the self-timer with a tripod	P.48 P.28 P.82 P.30
Monitor is blank	<ul style="list-style-type: none">• Camera is off.• Battery is not correctly inserted or battery chamber/memory card slot cover is not properly latched.• Battery is exhausted.• AC adapter is not properly connected.• Standby mode; press shutter-release button halfway.• The flash is being recharged while the battery is running low (). Wait until recharging has finished.• USB cable is connected.• Audio/video cable is connected.	P.24 P.18 P.24 – P.105 P.24 – –
Camera turns off without warning	<ul style="list-style-type: none">• Battery is exhausted.• Battery is cold.	P.24 P.135
No indicators appear in monitor	<ul style="list-style-type: none">• Hide info is selected for Photo info. Select Show info.	P.101
Monitor is hard to read	<ul style="list-style-type: none">• Ambient lighting is too bright; move to a darker location.• Monitor brightness needs adjustment.• Monitor is dirty; clean monitor.	P.134 P.101 P.134

Problem	Possible cause	Page
No picture is taken when shutter-release button is pressed	<ul style="list-style-type: none"> • Camera is in Playback mode. • Battery is exhausted. • Flash lamp blinks: flash is charging. • Message "CARD IS NOT FORMATTED" appears in monitor: memory card is not formatted for use in camera. • Message "MEMORY CARD IS WRITE PROTECTED." appears in monitor: memory card is locked. • Message "OUT OF MEMORY" appears on monitor: insufficient memory to record picture at current Image quality/size setting. 	<p>P.27</p> <p>P.24</p> <p>P.29</p> <p>P.21,</p> <p>P.106</p> <p>P.21</p> <p>P.136</p>
Pictures are too dark (underexposed)	<ul style="list-style-type: none"> • Flash is off. • Flash window is blocked. • Subject is outside range of flash. • Exposure compensation is too low. 	<p>P.28</p> <p>P.25</p> <p>P.28</p> <p>P.32</p>
Pictures are too bright (overexposed)	<ul style="list-style-type: none"> • Exposure compensation is too high. 	P.32
Pictures are out of focus	<ul style="list-style-type: none"> • Subject was not in focus area when shutter-release button was pressed halfway. • AF indicator flashes red: camera unable to focus. • AF-assist illuminator does not light when lighting is poor. Select Auto in the AF assist option. 	<p>P.26</p> <p>P.26</p> <p>P.104</p>
Randomly-spaced, brightly-colored pixels ("noise") appear in image	<ul style="list-style-type: none"> • Shutter speed is too slow. Noise can be reduced by: <ul style="list-style-type: none"> – Using flash – Selecting  NIGHT PORTRAIT,  NIGHT LANDSCAPE or  DUSK/DAWN in SCENE (scene) mode. (In these modes, Noise reduction works automatically when shutter speed is slow. Select an appropriate mode according to your shooting condition.) 	<p>P.28</p> <p>P.35,</p> <p>P.36,</p> <p>P.37</p>
Bright specks in picture	<ul style="list-style-type: none"> • Flash is reflecting from particles in air. Turn flash off or zoom in. 	<p>P.28,</p> <p>P.25</p>
Flash does not fire	<ul style="list-style-type: none"> • Flash is off. Note that flash turns off automatically when: <ul style="list-style-type: none"> – The mode dial is set to SCENE (scene) mode with  LANDSCAPE,  NIGHT LANDSCAPE,  SUNSET,  DUSK/DAWN,  FIREWORKS SHOW,  MUSEUM or  SPORTS selected in the Scene menu. – The mode dial is set to  (Except when recording a time-lapse movie). – Continuous (P.80) is set to Continuous, Multi-shot 16, Ultra HS, or 5 shot buffer in P or A mode. – BSS is On in P or A mode. – AUTO BRACKETING is set to Auto bracketing in P or A mode. 	<p>P.28</p> <p>P.33</p> <p>P.58</p> <p>P.80</p> <p>P.82</p> <p>P.83</p>
Colors are unnatural	<ul style="list-style-type: none"> • White balance does not match light source. 	P.46
Picture or voice memo cannot be played back	<ul style="list-style-type: none"> • Picture or voice memo has been overwritten or renamed by computer or by another model of camera. 	–

Problem	Possible cause	Page
Copy cannot be created using small picture, crop, or D-Lighting	<ul style="list-style-type: none"> • Picture is a retouched copy. • There is not enough free space in the memory or on the memory card to store new copy. Delete unwanted pictures from the memory to make free space. 	P.150 P.94
Cannot zoom in on picture	<ul style="list-style-type: none"> • Picture is a movie. • Picture was created with Small pic. option. • Picture has been cropped to sizes of 320 × 240 pixels or smaller. 	P.53
PictureProject does not start when camera is connected or memory card inserted in card reader or card slot	<ul style="list-style-type: none"> • Camera is off. • AC adapter is not properly connected, or battery is exhausted. • USB cable is not correctly connected, or card not properly inserted in card reader or card slot. • Camera is not properly recognized by computer. • USB in the INTERFACE menu set to PTP when camera connected to computer (Windows only). See <i>PictureProject reference manual</i> (on CD) for further information. 	P.24 P.24 P.62 – P.64
Signal is weak	<ul style="list-style-type: none"> • Set host. • Move closer to the access point. • Remove any obstacles between camera antenna and computer. • Change camera facing. 	P.114 –
Signal was interrupted and picture could not be sent	<ul style="list-style-type: none"> • Turn camera off and then turn it on again. 	P.123

Appendix

Default Settings (P.108)

For **Reset All** (P.108) restores the following default settings:

Scene menu	Default
SCENE	PORTRAIT (FACE AF)
Advanced option	Normal

Shooting menu	Default
White balance	Auto
Metering	Matrix
Continuous	Single
Intvl timer shooting	30s
BSS	Off
Auto bracketing	Off
Image adjustment	Auto
Image sharpening	Auto
Saturation control	Normal
Sensitivity	Auto
Image quality	NORMAL
Image size	 3264x2448
AF area mode	Auto
Auto-focus mode	Single AF
Fixed aperture	Off
Noise reduction	Off

Movie menu	Default
Movie options	TV movie 640
SET INTERVAL TIME of Time-lapse movie	30s
Auto-focus mode	Single AF

Playback menu	Default
Slide show Loop	Off

Set-up menu	Default
Menus	Icons
Welcome screen	Animation
Monitor settings	Photo info Brightness
Date imprint	Off
Shot confirmation	Off
AF assist	Auto
Sound Settings	Button sound Shutter sound Start-up sound
Auto off	1m
Auto transfer	On

Button setting	Default
Flash	
Exposure compensation	0
Self-timer	OFF
Focus	AF
Aperture for A (aperture-priority auto) mode	F2.7
Flexible program value for P (programmed auto) mode	0
Vibration reduction	Normal

Wireless transfer menu	Default
Shoot & Transfer	Confirm Transfer Save Images
	Off Off

- **Reset all** also clears the current file number (P.147) from memory. Numbering will continue from the lowest number available. To reset file numbering to 0001, perform **Reset all** after deleting all pictures (P.94) or formatting the internal memory or memory card (P.106).
- All other settings are unaffected, including **Date** (P.100), **Date counter** (P.103), **Language** (P.106), and **USB** and **Video mode** of **Interface** option (P.107).

Image Mode and Number of Exposures Remaining (P.43)

The following table shows the approximate number of pictures that can be stored in the internal memory and on a 256-megabyte memory card at different image modes. The number of exposures remaining varies widely, depending on the type of memory card, the nature of JPEG compression, and the content of the image.

Image Quality







Option	Description	Compression
FINE	Fine image quality, suitable for enlarged or high quality prints. File size reduced to roughly 1/4 of its original size.	 Low
NORMAL (default setting)	Normal image quality, suited to most situations. File size reduced to roughly 1/8 of its original size.	
BASIC	Basic image quality, suitable for pictures that will be distributed by e-mail or used on web pages. File size reduced to roughly 1/16 of its original size.	







Image Size

Select from the following options according to your shooting intent.

Image size (pixels)	Print size*
 3264×2448 (default setting)	28 × 21 cm (11 × 8 in.)
 2592×1944	22 × 16 cm (8.6 × 6.5 in.)
 2048×1536	17 × 13 cm (6.8 × 5.1 in.)
 1024×768	9 × 7 cm (3.4 × 2.6 in.)
 640×480	5 × 4 cm (2.1 × 1.6 in.)
 3264×2176	28 × 18 cm (11 × 7.3 in.)

* All figures are approximate. Print sizes assume a printer resolution of approximately 300dpi. The size of images when printed depends on the printer resolution: the higher the resolution, the smaller the final print size.





Image Quality/Size and Number of Exposures Remaining (P.43)

Image mode		Internal memory Approx. 23 MB	Memory card 256 MB
Image size	Image quality		
 3264×2448 (default setting)	FINE	6	60
	NORMAL	12	120
	BASIC	23	235
 2592×1944	FINE	9	95
	NORMAL	18	190
	BASIC	36	370
 2048×1536	FINE	15	150
	NORMAL	29	295
	BASIC	56	560
 1024×768	FINE	56	560
	NORMAL	104	1,015
	BASIC	181	1,690
 640×480	FINE	128	1,265
	NORMAL	217	2,175
	BASIC	331	3,045
 3264×2176	FINE	6	95
	NORMAL	13	135
	BASIC	26	265

- If number of exposures remaining is 10,000 or more, camera exposure count display will show 9999.

Movie Options and Maximum Total Recording Time (P.56)

Approximate maximum total recording time for the memory card is indicated as a guide. Actual total recording time varies depending on the make of memory cards even when they have the same memory capacity.

Option	Max. recording time	
	Internal memory (Approx. 23 MB)	Memory card (256 MB)
 TV movie 640* (default setting)	16 s	2 m 50 s
 Small size 320	38 s	6 m 25 s
 Smaller size 160	2 m 27 s	24 m 50 s
 Time-lapse movie	19 s (584 frames)	35 s (1,050 frames)

- * To prevent **TV movie 640** from ending unexpectedly, use a card rated for 10 MB/s.

Settings for Scene Mode (P.35)

The following table shows each default setting for the Scene modes. Each setting returns to default when the power is turned off, mode is altered, Playback mode is set or **Reset all** in Set-up menu is performed. However, settings in brackets are invariable.

Scene mode (P.33)	Flash (P.28)	Focus (P.31)	Self-timer (P.30)	Exposure compensation (P.32)	AF-Assist Illuminator (P.26)
PORTRAIT (FACE AF)		[AF]	Off	0.0	[Auto]
PORTRAIT		[AF]	Off	0.0	[Auto]
PARTY/INDOOR		[AF]	Off	0.0	[Auto]
NIGHT PORTRAIT		[AF]	Off	0.0	[Auto]
LANDSCAPE	[[Off	0.0	[Off]
PANORAMA ASSIST		AF/	Off	0.0	[Auto]
NIGHT LANDSCAPE	[[Off	0.0	[Off]
BEACH/SNOW		AF/	Off	0.0	[Auto]
SUNSET	[[Off	0.0	[Off]
DUSK/DAWN	[[Off	0.0	[Off]
FIREWORKS SHOW	[[[Off]	[0.0]	[Off]
BACK LIGHT	[[AF]	Off	0.0	[Auto]
CLOSE UP		[Off	0.0	[Auto]
MUSEUM	[AF/	Off	0.0	[Off]
COPY		AF/	Off	0.0	[Auto]
SPORTS	[[AF]	[Off]	0.0	[Auto]

- Digital zoom is not available with PORTRAIT (FACE AF), PORTRAIT, and NIGHT PORTRAIT mode.
- In Scene mode, the camera automatically selects optimal focus area for the selected mode.
- AF-assist illuminator will not light when the center focus area is not selected in CLOSE UP mode.
- **Date imprint** is automatically canceled in PANORAMA ASSIST (P.36) mode.

Image File and Folder Names

In the internal memory or on the memory card, pictures are identified by file names with three parts: a four-letter identifier, a four-digit file number assigned automatically by the camera in ascending order, and a three-letter extension (e.g., "DSCN0001.JPG"). When a picture is viewed on the monitor, the file number and extension appear in the top right corner of the display. The identifier is not displayed, but is visible when images are transferred to a computer.

Picture type		Identifier	Extension	Page
Original	Still picture	DSCN	.JPG	P.49
	Movie	DSCN	.MOV	P.60
	Time-lapse movie	INTN	.MOV	P.59
Copy	Copy created using Small pic.	SSCN	.JPG	P.96
	Cropped copy	RSCN	.JPG	P.54
	Copy created using D-Lighting	FSCN	.JPG	P.92
Audio file	Voice memo	DSCN, RSCN, SSCN, FSCN	.WAV	P.55

- Pictures are stored in a folder created automatically by the camera. The folder name includes a three-digit folder number (e.g., 100NIKON). Folders can hold up to 200 pictures; if a picture is taken when the current folder contains 200 pictures, a new folder will be created by adding one to the largest folder number (e.g., 100NIKON → 101NIKON).
- When taking pictures using **☒ PANORAMA ASSIST** (P.40), **Ultra HS** (P.80), or **Intvl timer shooting** (P.80), each sequence of pictures is stored in a folder with a name consisting of a three-digit folder number followed by "XXXP_xxx", "XXXN_xxx", or "XXXINTVL" (e.g., "101P_001", "101N_001" or "101INTVL").
- If you take a picture when the current folder contains a picture numbered 9999, a new folder will be created and file numbering will begin again from 0001.
- If file number reaches 200 or picture number reaches 9999 when the internal memory or the memory card contains a folder numbered 999, no further pictures can be taken, even if there is still memory capacity. Replace the memory card, or transfer all pictures to a computer (P.62), and after formatting the internal memory or the memory card (P.106), perform **Reset all** (P.108).

Getting Good Results with Autofocus (P.26, 87)

Autofocus performs best when there is contrast between the subject and the background and the subject is evenly lit. It does not perform well if the subject is very dark or moving rapidly, if there are objects of sharply differing brightness in the scene (e.g., the sun is behind your subject and their features are in deep shadow), or if there are several objects at different distances from the camera at the center of the frame (e.g., your subject is inside a cage).

Time Zone (P.100)

The camera supports the following time zones. Time zone increments of less than one hour are not supported. When traveling to or from destinations at half- or quarter-hour increments from Greenwich Mean Time (GMT), set the camera clock to local time (P.100).

GMT +/-	Location
GMT -11	Midway, Samoa
GMT -10	Hawaii, Tahiti
GMT -9	Alaska, Anchorage
GMT -8	PST (PDT*): Los Angeles, Seattle, Vancouver
GMT -7	MST (MDT*): Denver, Phoenix, La Paz
GMT -6	CST (CDT*): Chicago, Houston, Mexico City
GMT -5	EST (EDT*): New York, Toronto, Lima
GMT -4	Caracas, Manaus
GMT -3	Buenos Aires, Sao Paulo
GMT -2	Fernando de Noronha
GMT -1	Azores

GMT +/-	Location
GMT	London, Casablanca
GMT +1	Madrid, Paris, Berlin
GMT +2	Athens, Helsinki
GMT +3	Moscow, Nairobi
GMT +4	Abu Dhabi, Dubai
GMT +5	Islamabad, Karachi
GMT +6	Colombo, Dhaka
GMT +7	Bangkok, Jakarta
GMT +8	Beijing, HK, Singapore
GMT +9	Tokyo, Seoul
GMT +10	Sydney, Guam
GMT +11	New Caledonia
GMT +12	Auckland, Fiji

* When daylight saving time is turned on.

Notes on Focus Area Selection

- In Movie mode, camera automatically focuses on the subject using the center focus area. **AF area mode** cannot be used.
- While digital zoom (P.25) is in effect, the center focus area is used. **AF area mode** cannot be used.
- Notes on Shooting in **Manual** Flash (P.28), self-timer (P.30), focus (P.31), and exposure compensation (P.32) cannot be set while the focus area selection guide and selectable area are displayed. Press **OK** to hide the focus area selection guide before adjusting these settings. To change focus area, press **OK** again after making settings for each mode.

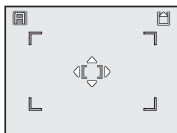

When the focus area and selectable area are displayed

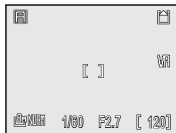









When the focus area and selectable area are hidden

Options for ISO Sensitivity (P.45)



 Auto (default setting)	Approximately equivalent to ISO 50 is set as default. When lighting is poor, however, camera automatically compensates by raising sensitivity to maximum of ISO 200 equivalent.
50	Approximately equivalent to ISO 50.
100	Approximately equivalent to ISO 100.
200	Approximately equivalent to ISO 200.
400	Approximately equivalent to ISO 400.

Options for White Balance (P.46)

 Auto (default setting)	Automatically adjusts white balance to suit lighting conditions. Best choice for most situations.	
 White bal. preset	Gray object used as reference to set white balance under unusual lighting conditions (P.47).	
 Direct sunlight	Use under direct sunlight.	
 Incandescent	Use under incandescent lighting.	
 Fluorescent	FL1	Use under most types of fluorescent lighting. Select FL1 (White) or FL2 (Daylight White/Natural) according to the bulb types, and then press  .
	FL2	
 Cloudy	Use under overcast skies.	
 Shade	Use under sunny skies when your subject is in the shade.	
 Flash	Use when taking pictures with the flash.	

Auto Off (P.105)

When the camera enters Standby mode and the power-on lamp blinks, perform one of the following operations to reactivate the camera:

- Pressing the power switch
- Pressing the shutter-release button halfway
- Pressing  (camera enters Playback mode except when mode dial is set to )
- Pressing **MENU** (the menu for the selected mode is displayed)

The length of time is fixed in the following cases:

- When a menu is displayed with **Auto off** set to thirty seconds (**30s**) or one minute (**1m**): 3 minutes
- When pictures are being played back in a slide show: 30 minutes
- When camera is in Wireless transfer mode: 3 minutes (Auto off does not activate while pictures are being transferred)
- When using the optional EH-62A AC adapter kit: 30 minutes

Auto off does not activate when the supplied USB cable is connected.

Restrictions on Editing Images

You can edit images by trimming them (cropping), adjusting the brightness (D-Lighting), or creating a smaller copy (Small picture). The following restrictions apply when editing an image that has already been edited.

First Edit	Second Edit		
	Cropping	D-Lighting	Small Picture
Cropping	× *	×	×
D-Lighting	○	×	○
Small Picture	×	×	×

* When attempting to apply a second edit, the message “IMAGE CANNOT BE SAVED” appears.

- Pictures with **Image size** set to **3264×2176** or shot with **Continuous** set to **Ultra HS** or **Intvl timer shooting** cannot be edited.

Notes on Editing Images:

- Editing images from another model of camera is not supported.
- Images edited with this camera may not properly play back on another model of camera or transfer to a computer.
- Edited images are separate images from the original. Deleting one does not delete the other.
- If there is not enough space in the destination memory, the edited image cannot be saved.
- The recording date for the image data is the same as that of the original image.

Specifications

Nikon COOLPIX P3 Digital Camera

Type	Compact digital camera
Effective pixels	8.1 million
Image sensor	1/1.8 in. high-density CCD; total pixels: 8.3 million
Image size (pixels)	<ul style="list-style-type: none">• 3,264 × 2,448 [8M]• 2,048 × 1,536 [3M]• 640 × 480 [TV]• 2,592 × 1,944 [5M]• 1,024 × 768 [PC]• 3,264 × 2,176 [3:2]
Lens	3.5× Zoom-Nikkor lens
Focal length	7.5 - 26.3 mm (Picture angle: Equivalent to 35 mm [135] format is approx. 36 - 126 mm)
f/-number	f/2.7 - 5.3 (Seven elements in six groups), with lens cover
Vibration reduction	Lens shift
Digital zoom	Up to 4× (Picture angle: Equivalent to 35 mm [135] format is approx. 504 mm)
Autofocus (AF)	Contrast-detect through-the-lens (TTL) AF, AF-assist illuminator
Focus range	30 cm (1 ft.) - ∞ (W); macro mode 4 cm (1.6 in.) - ∞ (W)
Focus area selection	Auto (11-area automatic selection), Manual (99-area manual selection), Center (center focus area selection)
AF-assist illuminator	CLASS 1 LED PRODUCT (IEC 60825-1 Edition 1.2 ⁻²⁰⁰¹) Maximum output: 3,050 μW
LCD Monitor	2.5 in., 150,000-dot, amorphous silicon TFT transfective LCD with five level brightness adjustment
Frame coverage (Shooting mode)	Approx. 98% horizontal and 98% vertical
Storage	
Media	Internal memory (approx. 23 MB) SD (Secure Digital) Memory cards
File system	Compliant with Design Rule for Camera File System (DCF), Exif 2.2, and Digital Print Order Format (DPOF)
File formats	Compressed: JPEG-baseline-compliant (1:4, 1:8, 1:16) Movies: QuickTime Sound files: WAV
Exposure	
Metering	Through-the-lens (TTL) metering; <ul style="list-style-type: none">• 256-segment matrix• Center-weighted• Spot• Spot AF area
Exposure control	Programmed auto, Aperture-priority auto, Exposure compensation (-2.0 - +2.0 EV in steps of 1/3 EV), Auto bracketing

Range	W : 2 - 17 EV T : 3 - 16 EV (Sensitivity: Auto)
Shutter	Combined mechanical and CCD electronic shutter
Speed	8 - 1/2,000 s
Aperture	Six-blade hexagonal iris diaphragm
Range	10 (in steps of 1/3 EV)
ISO Sensitivity	Approx. equivalent to ISO 50, 100, 200, 400; Auto (auto gain setting from ISO 50 to 200 equivalent)
Self-timer	10 or 3-second duration
Built-in Flash	
Range	W : Approx. 0.4 - 4.0 m (1 ft. 4 in. - 13 ft. 1 in.) T : Approx. 0.4 - 2.0 m (1 ft. 4 in. - 6 ft. 7 in.) (Sensitivity: Auto)
Flash control	Sensor flash system
Interface	USB, IEEE 802.11b/g
Video output	Can be selected from NTSC and PAL
I/O terminals	DC in; Digital I/O (audio-video out and USB)
Supported language	Czech, Danish, German, English, Spanish, French, Indonesian, Italian, Dutch, Norwegian, Polish, Portuguese, Russian, Finnish, Swedish, Chinese (Simplified and Traditional), Japanese, Korean, Thai
Power sources	<ul style="list-style-type: none"> • One Nikon Li-ion Rechargeable Battery EN-EL5 (supplied) • EH-62A AC Adapter kit (available separately)
Battery life ^{*1}	Approx. 200 shots, with EN-EL5 battery
Dimensions (W×H×D)	Approx. 92 × 61 × 31 mm (3.6 × 2.4 × 1.2 in.) excluding projections
Weight	Approx. 170 g (5.6 oz.) without battery or memory card
Operating environment	
Temperature	0 - 40°C (32 - 104°F)
Humidity	Less than 85% (no condensation)

^{*1} Based on Camera and Imaging Products Association (CIPA) standard for measuring life of camera batteries.

Measured at 25°C (77°F); zoom adjusted with each shot, flash fired with every other shot, image quality set to **NORMAL**, image size set to  **3264×2448**, Vibration reduction set to **VR** (Normal).

Wireless Transfer	
Standards	IEEE 802.11b/g (standard wireless LAN protocol), ARIB STD-T66 (standard for low power data communications systems)
Communication protocols	IEEE 802.11g: OFDM IEEE 802.11b: DBPSK, DQPSK, CCK
Range (line of sight)	Approx. 30 m (98 ft.) Range may vary depending on the weather or obstacles.
Operating frequency	2,412 - 2,462 MHz (11 channels)
Data rates^{*2}	IEEE 802.11g: 6, 9, 12, 18, 24, 36, 48, and 54 Mbps IEEE 802.11b: 1, 2, 5.5, and 11 Mbps
Security	TKIP, 128/64-bit WEP
Access protocols	Infrastructure/ad-hoc

^{*2} Maximum logical data rates according to IEEE standard. Actual rates may differ.

- Industry standard for measuring life of camera batteries. Measured at 25°C (77°F); zoom adjusted with each shot, built-in flash fired with every other shot, image quality set to **NORMAL**.

MH-61 Battery Charger

Rated input	AC 100 - 240 V, 50/60 Hz, 0.12 - 0.08 A
Charging output	DC 4.2 V, 950 mA
Compatible battery	Nikon Li-ion Rechargeable Battery EN-EL5
Charging time	Approx. 2 hrs. when no charge remains
Operating temperature	0 - 40°C (32 - 104°F)
Dimensions (W×H×D)	Approx. 67 × 26 × 67 mm (2.6 × 1.0 × 2.6 in.)
Length of cable	Approx. 1.8 m (6 ft.)
Weight	Approx. 65 g (2.3 oz.) excluding power cable

EN-EL5 Rechargeable Li-ion Battery

Type	Rechargeable lithium-ion battery
Rated capacity	3.7 V, 1,100 mAh
Dimensions (W×H×D)	Approx. 36 × 54 × 8 mm (1.4 × 2.1 × 0.3 in.) excluding projections
Weight	Approx. 30 g (1 oz.) excluding terminal cover

Specifications

- Nikon will not be held liable for any errors this manual may contain.
- The appearance of this product and its specifications are subject to change without notice.

Design Rule for Camera File system (DCF)

This camera conforms to the Design rule for Camera File system (DCF), a standard widely used in the digital camera industry to ensure compatibility among different makes of camera.

Digital Print Order Format (DPOF)

















DPOF is an industry-wide standard that allows pictures to be printed from print orders stored on the memory card. To print pictures using **Print set**, check that printers or your local photo labs supports DPOF.

Exif Version 2.2

This camera supports Exif (Exchangeable Image File Format for Digital Still Cameras) version 2.2, a standard that allows information stored with pictures to be used for optimal color reproduction when images are output on Exif-compliant printers.

Index

Symbols

- A** Aperture-priority auto, 12, 41, 42
-  Auto shooting mode, 12, 24-26
-  Delete button, 13, 27, 51, 94
-  Exposure compensation, 13, 32, 42
-  Flash lamp, 29
-  Flash mode, 13, 29
-  Focus mode, 13, 31
-  Help button, 13, 15, 122
-  Image mode, 12, 44
- ISO** ISO Sensitivity mode, 12, 45
- MENU** Menu button, 13, 76
-  Movie mode, 12, 56, 58
-  OK button, 13
-  Play button, 13, 27, 49
- P** Programmed auto, 12, 41
- SCENE** Scene mode, 12, 33
-  Self-timer, 13, 30
- SET UP** Set-up menu, 12, 76
- Q T** button, 13, 25, 52
-  Transfer button, 13, 64
-  Vibration reduction, 12, 48
-  **W** button, 13, 25, 50
- WB** White balance mode, 12, 46
-  Wireless transfer mode, 12, 122, 130



Numerics

5 shot buffer, 80



A

- AC adapter kit, 19, 132
- Advanced options, 33-34
- AF area mode**, 86
- AF assist**, 104
- AF lock, 87
- AF-assist illuminator, 12, 26, 104
- Antenna, 12
- Audio/video (A/V) cable, 61
- Audio/video (A/V) out connector, 13, 61
- Auto bracketing**, 83
- Auto off**, 25, 105, 149
- Auto transfer**, 107
- Autofocus, 31, 147
- Auto-focus mode**, 57, 87
 - Full-time AF**, 57, 87
 - Single AF**, 57, 87

B

- BACK LIGHT** , 37, 146
- Backlit subject, 92
- Battery, 16-19, 135
 - charging, 16-17
 - latch, 13, 18
- Battery chamber/Memory card slot cover, 13, 19
- Battery charger, 16, 132
- Battery level, 24
- BEACH/SNOW** , 36, 146
- Blur, 35, 37, 48
 - see also Vibration reduction
- BSS**, 82

C

- Camera shake, see Vibration reduction
- Choose date**, 72, 91, 94, 95
- Clock battery, 100
- Clock, see **Date**
- CLOSE UP** , 38, 146
- Close-ups, 31, 38
- Cloudy**, 149
- Computer, 62, 64
- Continuous**, 80
 - 5 shot buffer**, 80
 - Intvl timer shooting**, 80, 81
 - Multi-shot 16**, 80
 - Single**, 80
 - Ultra HS**, 80, 81
- Contrast, 84
- Copy**, 97
- COPY** , 38, 146
- Cropping pictures, 54, 150

D

- Date**, 22-23, 100
- Date imprint**, 75, 102
 - Date counter**, 102, 103
- DaylightSaving**, 23, 100
- DCF, 154
- Delete**, 94
 - Deleting pictures, 27, 51, 94
 - during shooting, 27
 - selected pictures, 94
- Digital zoom, 25

Direct sunlight, 149

D-Lighting, 92, 150

DPOF, 70, 72, 75, 154

DSCN, 147

DUSK/DAWN , 37, 146

E

EG-CP14, *see* Audio/video (A / V) cable

EH-62A, *see* AC adapter kit

E-mail attachments, 96

EN-EL5, 16, 18, 132, 153

see also Battery

Error messages, 136-139

Exif 2.2, 154

Exposure compensation, 32, 42

Exposure modes, 41

Extension, 147

F

File name, 55, 97, 147

File numbering, 108, 147

Fill flash, 28

FIREWORKS SHOW , 37, 146

Firmware version, 108

Fixed aperture, 42, 88

Flash, 13, 28, 29, 45

Flash mode, 14, 28, 29

Anytime flash, 28

Auto, 28

Auto with red-eye reduction, 28

Flash cancel, 28

Slow sync, 28

Flexible Program, 41

Fluorescent, 149

Focus, 26, 31

Focus area, 14, 86

Focus indicator, 14, 26

Focus mode, 31

infinity, 31

Macro close-up, 31

Folder name, 147

Format memory/card, 106

Format, 21, 106

internal memory, 106

memory card, 106

Quick format, 106

FSCN, 147

Full-screen playback, 49

H

Histogram, 32, 42, 51

I

Identifier, 147

Image adjustment, 14, 84

Image mode, 44

Image quality, 14, 43-44

Image size, 14, 43-44

Image sharpening, 14, 84

Incandescent, 149

Interface, 107

connector cover, 13

USB, 64, 107

Video mode, 107

Internal memory icon, 26

ISO Sensitivity, 14, 45, 88, 149

J

JPEG, 43, 144

L

Lamp, Flash, 29

LANDSCAPE , 36, 146

Language, 22, 106

Lens, 12, 134

Lens cover, 12

List by date, 92

M

Macro mode, 31, 38

Memory card, 20-21

approved, 132

formatting, 11, 106

inserting and removing, 20-21

slot cover, 13, 20-21

Memory card icon, 26

Menus, 99

Icons, 99

Text, 99

Metering, 79

Center-weighted, 79

Matrix, 79

Spot, 79

Spot AF area, 79

MH-61, *see* Battery charger

Microphone, 12, 55

Mode dial, 12

Monitor, 13, 14-15, 134
 indicators, 14-15
Monitor brightness, 101
Monitor settings, 101
 Brightness, 101
 Photo info, 101
MOV, see Movies
Movie menu, 56, 76
Movie options, 56, 145
 Small size 320, 56, 145
 Smaller size 160, 56, 145
 Time-lapse movie, 56, 59, 145
 TV movie 640, 56, 145
Movies, 56-60, 145
 recording, 58-59
 viewing, 60
Multi Selector, 13, 22
Multi-shot 16, 80
MUSEUM , 38, 146





N

NIGHT LANDSCAPE , 36, 146
NIGHT PORTRAIT , 35, 146
Noise reduction, 88
NTSC, see Video output
Number of exposures remaining, 24, 145

O

On/off, see Power switch

P

PAL, see Video output
PANORAMA ASSIST , 36, 40, 146
Paper size, 69, 70
PARTY/INDOOR , 35, 146
PictBridge, 69
PictureProject, 62
Playback menu, 76, 89
Playing back, 27, 49-50, 55, 60
 full-screen, 49
 movies, 60
 on TV, 61
 thumbnail, 50
 zoom, 52, 53
PORTRAIT (FACE AF) , 35, 39, 146
PORTRAIT , 35, 146
Power connector cover, 12
Power switch, 12
Power-on Lamp, 12, 24

PRINT MENU, 70

DPOF printing, 70, 75
 Paper size, 69, 70
 Print all images, 70
 Print selection, 70

Print set, 72

Printer, 67, 130
Printing pictures, 69, 70-71
 see also **Date imprint**, DPOF
Profile
 confirming, 120
Protect, 94
Protected pictures, 94, 97

Q

Quality, see Image mode
Quick format, 106
Quick Playback Zoom, 52
QuickTime, see Movies

R

Reset all, 108, 143
Resizing pictures, 96, 150
RSCN, 147

S

Saturation, 85
Saturation control, 85
Scene mode, 33-40
Secure Digital (SD), see Memory card
Self-portraits, 30
Self-timer, 30
 Self-timer lamp, 12, 30
Sensitivity, 45, 88, 149
Setup menu, 76, 98-108
Shade, 149
Shake, see Vibration reduction
Shooting menu, 76, 78-88
Shot confirmation, 104
Shutter-release button, 12
Shutter-release delay, see **Self-timer**
Single, 80
Size, see Image mode
Slide show, 93
Small pic., 96
Smear, 134
Sound settings, 105
 Button sound, 105
 Shutter sound, 105
 Start-up sound, 105

Speaker, 13

SPORTS , 38, 146

SSCN, 147

Standby mode, 25, 105, 121

Strap, camera, 12

SUNSET , 37, 146

Support information, 11

T

Telephoto button, see **Q T** button

Thumbnail playback, 50

Time zone, 22, 100

Transfer

marking pictures for, 95

Transfer marking, 95

Tripod, 13, 30

TV

connecting to, 61

U

UC-E6, see USB cable

USB, 62, 64, 68, 107

Mass storage, 64, 107

PTP, 64, 107

USB cable, 62, 68

USB connector, 12

V

Vibration reduction, 48

Video mode, 107

Video output, 61

Voice memo, 55

Voice memo icon, 55

Volume, 60, 105

W

WAV, 55, 147

Welcome screen, 99

White balance, 46, 149

Auto, 46, 149

Cloudy, 149

Direct sunlight, 149

Flash, 149

Fluorescent, 149

Incandescent, 149

Shade, 149

White bal-preset, 47

Wide angle button, see **W** button

WIRELESS MENU, 122

Easy Transfer, 121, 124

Marked Images, 121, 126

PC mode, 121, 129

Selected Images, 121, 127

Shoot & Transfer, 121, 128

Shooting Date, 121, 125

Wireless printing, 121, 130

Wireless transfer LED, 13, 123

Wireless Transfer Mode, 109-131

Z

Zoom, 25

digital, 25

optical, 25

playback, 53

Quick playback, 52

Nikon

No reproduction in any form of this manual, in whole or in part (except for brief quotation in critical articles or reviews), may be made without written authorization from NIKON CORPORATION.

NIKON CORPORATION
Fuji Bldg., 2-3 Marunouchi 3-chome,
Chiyoda-ku, Tokyo 100-8331, Japan

Printed in Belgium
TR6A01(11)
6MA17711-01

Web only